

Indoor Dome Camera

DWC-D2382TIR



OMNI-PLUS™

ABOUT MANUAL

Before installing and using the camera, please read this manual carefully.
Be sure to keep it handy for future reference.

PRECAUTIONS

- Do not open or modify.
- Do not open the case except during maintenance and installation, for it may be dangerous and can cause damages.
- Do not put objects into the unit.
- Keep metal objects and flammable substances from entering the camera. It can cause fire, short-circuits, or other damages.
- Be careful when handling the unit.
- To prevent damages, do not drop the camera or subject it to shock or vibration.
- Do not install near electric or magnetic fields.
- Protect from humidity and dust.
- Protect from high temperature.
- Be careful when installing near the ceiling of kitchen or a boiler room, as the temperature may rise to high levels.
- Cleaning:
To remove dirt from the case, moisten a soft cloth with a soft detergent solution and wipe.
- Mounting Surface:
The material of the mounting surface must be strong enough to support the camera.

FCC COMPLIANCE

This equipment has been tested and found to comply with the limits for a Class B digital device, pursuant to part 15 of the FCC rules. These limits are designed to provide reasonable protection against harmful interference, when the equipment is operated in a residential environment. This equipment generates, uses, and radiates radio frequency energy; and if it is not installed and used in accordance with the instruction manual, it may cause harmful interference to radio communications.

WARNING: Changes or modifications are not expressly approved by the manufacturer.

TABLE OF CONTENTS

Introduction	Features	4
	Parts and Descriptions	5
	Dimensions	6
Installation	Inside the Box	7
	Mount Installation Instructions	8-9
	Connecting to Monitors	10
	Adjusting the Camera Lens	11
	Adjusting the 3-Axis Gimbal	12
Module OSD Menu		13-24
Remote Control		25
Troubleshooting		26
Warranty Information		27-28
Specifications		29-30

FEATURES*

- 1/3" Sony Super HAD CCD II
- 620 TV Lines (B&W), 600 TV Lines (Color)
- OMNI-Focus 2.9~8.5mm Auto Iris Lens
- 3X Motorized Zoom
- 70ft Range IR with Intelligent Camera Sync
- TDN (True Day and Night / IR Cut Filter)
- Smart DNR (Digital Noise Reduction)
- WDR (Wide Dynamic Range)
- Star-Light (Super Low Light Technology)
- HME (Highlight Masking Exposure)
- Programmable Privacy Zones & Motion Detection
- Easy Icon Driven OSD Menu with Built-In Joystick
- Auto Sensing 12VDC or 24VAC with Line Lock
- RS-485 Built-in
- Secondary Video-BNC Output

PARTS & DESCRIPTION*

- 1** Lens
- 2** Primary Video-BNC Output Connector
- 3** Power Input Connector (12VDC/24VAC)
- 4** Bottom Case
- 5** Mounting Screws
- 6** Black Lens Cover
- 7** Bubble Dome
- 8** Upper Case Ring
- 9** Assembly Screws

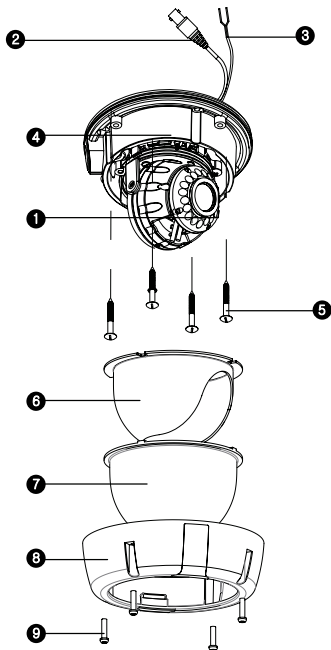

DIMENSIONS IN MILLIMETERS (IN)*

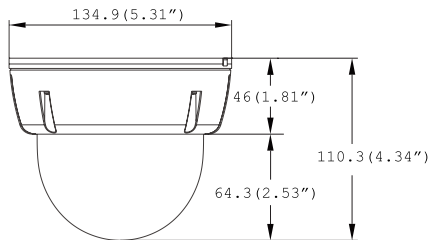

INSIDE THE BOX*

Included with D2 Indoor Dome Camera

- 1 User Manual
- 2 Mounting Template
- 3 2 Machine Screws and 2 Dry Wall Anchors
- 4 Miniature TORX Driver
- 5 L-Key
- 6 Secondary Video-BNC Cable
- 7 IR Remote Controller



1

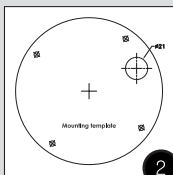

2



3



4

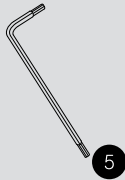

5



6



7

CAMERA INSTALLATION*

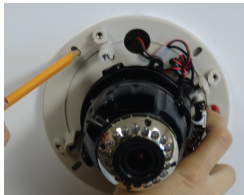

- 1** Cut a hole in the ceiling for routing the cables. Use your mounting template to mark the screw holes.



- 2** Drill holes into the drywall and insert the drywall mounts into the holes.

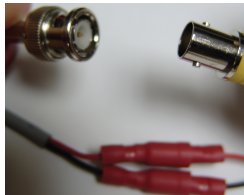

- 3** Pull wires through and make connections.

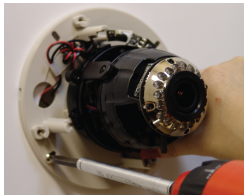

- 4** Mount and secure the camera to the surface using the machine screws.



- 5** Position the lens and adjust the zoom and focus.



- 6** Assemble the black lens cover and outer dome cover with the camera module.

WALL MOUNT INSTALLATION*



- 1** Check to see all parts are in the box.



- 2** Use the mount to mark the pilot holes are required. Drill holes into the drywall and insert the drywall mounts.



- 3** Secure the wall mount to the wall using the mounting screws.

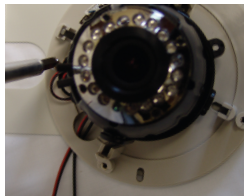

- 4** Attach the base of the camera to the wall mount with the smaller machine screws.



- 5** Position the lens and adjust the zoom and focus.

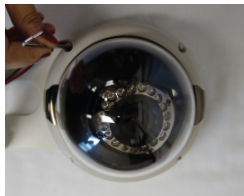

- 6** Assemble the black lens cover and outer dome cover with the camera module.

CONNECTING TO MONITORS*

DC12V / AC24V

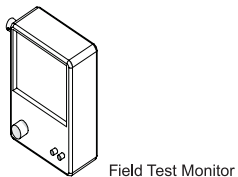
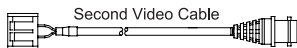
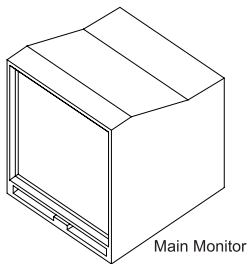
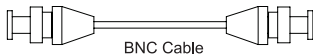
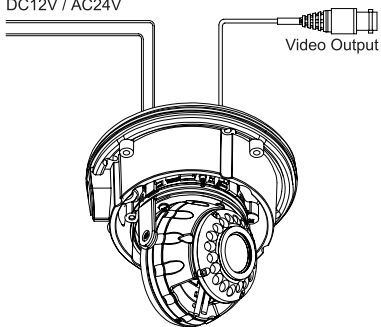

ADJUSTING THE CAMERA LENS*

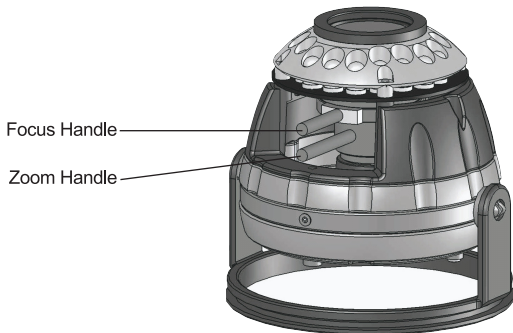

- 1 Loosen the zoom and focus handles by rotating them counter-clockwise.
- 2 Adjust the field of view by moving the handle to the RIGHT (tele) to zoom in or to the LEFT (wide) to zoom out.
- 3 AFTER the desired zoom position is established, adjust the focus the same way as described above.
- 4 Once the desired adjustments have been made, please tighten the handles back by turning them clockwise.

ADJUSTING THE 3-AXIS GIMBAL*

The Gimbal mechanism yields maximum rotation and placement as shown below.



360.0°



360.0°



90.0°

MODULE OSD MENU*

EXPOSURE	COLOR	DAY & NIGHT	FUNCTION
<ul style="list-style-type: none"> — LENS MANUAL / DC — BACKLIGHT OFF / BLC / HME / WDR — AGC OFF / LOW / MID / HIGH / HIGHEST — STARLIGHT OFF / x2 ~ x1024 — 3D DNR OFF / LOW / MID / HIGH / SMART — EXIT JUMP SAVE & EXIT / EXIT 	<ul style="list-style-type: none"> — WB MODE AWC / ATW / MANUAL / PUSHLOCK — RED GAIN 0 ~ 255 — BLUE GAIN 0 ~ 255 — COLOR MODE NORMAL / COOL / WARM — EXIT JUMP SAVE & EXIT / EXIT 	<ul style="list-style-type: none"> — D&N MODE AUTO / COLOR / B&W — NIGHT C. 0 ~ 100 — NIGHT A. 0 ~ 100 — EXIT JUMP SAVE & EXIT / EXIT 	<ul style="list-style-type: none"> — MIRROR MIRROR / OFF — SHARPNESS 0 ~ 30 — GAMMA MANUAL / 0.45 / 0.60 / 1.0 — SLC OFF / ON — NIGHT UP OFF / ON — EXIT JUMP SAVE & EXIT / EXIT
MOTION	PRIVACY	SETUP	EXIT
<ul style="list-style-type: none"> — AREA SET AREA 1~4 > OFF / ON — SENSITIV. 1 ~ 50 — SHOW INDI. OFF / ICON / TRACE — EXTER-OUT. OFF / ON — EXIT JUMP SAVE & EXIT / EXIT 	<ul style="list-style-type: none"> — MASK 1 OFF / ON — MASK 2 OFF / ON — MASK 3 OFF / ON — MASK 4 OFF / ON — MASK 5 OFF / ON — MASK 6 OFF / ON — MASK 7 OFF / ON — MASK 8 OFF / ON — EXIT JUMP SAVE & EXIT / EXIT 	<ul style="list-style-type: none"> — TITLE EDIT OFF / ON — DPC SET OFF / AUTO — MONITOR MODE 1 / MODE 2 — LANGUAGE ENGLISH / 繁體中文 / 簡體中文 / 日本語 / DEUTSCH / FRENCH / ITALIAN / RUSSIAN / SPANISH / DUTCH — OSD COLOR BLUE / GREEN / CYAN / RED / MAGENTA / YELLOW / PURPLE / GRAY — COMMUNICATION OFF / ON — FACTORY SET. NO / YES — EXIT JUMP SAVE & EXIT / EXIT 	<ul style="list-style-type: none"> — SAVE & EXIT — EXIT



EXPOSURE



LENS

Manual Manual mode supports the fixed board lens or the manual iris lens.

DC DC mode supports the auto-iris varifocal lens.

NOTE: Both MANUAL and DC mode have FOCUS TARGET. You can adjust the focus by finding the highest number on the FOCUS TARGET. See page 16 for focus information.

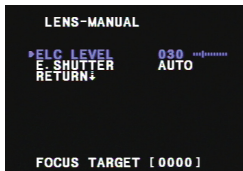

ELC Levels and DC Levels are adjustable. The higher the number, the brighter the image.

E. Shutter sets the shutter speed levels from 1/60 to 1/100000.

*For LENS-MANUAL Mode, the default E.SHUTTER is AUTO.

*For LENS-DC Mode, the default E.SHUTTER is 1/60. Select DC-AUTO for *outdoor use.

Select 1/100FLC to run camera in flickerless mode.

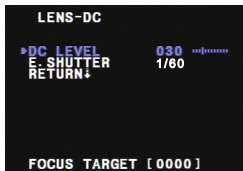

Note: The STARLIGHT option cannot be controlled if the E.SHUTTER setting is above 1/60.



EXPOSURE

BACKLIGHT

OFF

BLC BACK LIGHT COMPENSATION

MANUAL User can manually adjust the BLC level in five areas of the scene (TOP, BOTTOM, CENTER, LEFT, RIGHT). Increase the BLC levels to make the image brighter.

SMART This is recommended. Camera will automatically detect and adjust the BLC zone. BLC levels to choose from include: LOWEST, LOW, MID, HIGH.

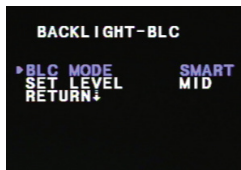

HME HIGHLIGHT MASKING EXPOSURE

HME masks highlights to allow objects to appear clearly on the screen. If ON is selected, HME levels are adjustable. The lower the number, the darker the masking areas.

WDR (TRUE) WIDE DYNAMIC RANGE

True WDR in this camera is not supported by a double scan CCD. However, this special DSP can automatically perform two scans depending on the lighting.



EXPOSURE

AGC

OFF / LOW / MID / HIGH / HIGHEST

AUTO GAIN CONTROL

AGC enhances the picture brightness in low light conditions. A higher level AGC setting makes the images brighter; however, it could increase the amount of noise.

STARLIGHT

OFF / x2 ~ x1024

Starlight mode automatically activates slow shutter function when the image is too dark. x4 is the default. We do not recommend you to increase the setting, for it causes the image to lag.

Note: Starlight menu cannot be controlled if the E.SHUTTER setting is above 1/60.

3D DNR

OFF / LOW / MID / HIGH / SMART

3D DIGITAL NOISE REDUCTION

3D-DNR reduces the noise on the screen in low light conditions and allows for clearer images, even at night. The SMART option will adjust the camera to prevent lagging when there is motion.

EXIT JUMP

SAVE & EXIT
EXIT

Save the current settings and exit the OSD menu.
Exit the OSD menu without saving the changes.



COLOR

WB MODE



- AWC Auto White Balance Control mode compensates for color temperature changes between 2000K and 18000K.
- ATW Auto Tracking White Balance Control mode compensates for color temperature changes between 2500K and 9500K.
- MANUAL Users can control the white balance manually by changing RED GAIN and BLUE GAIN (see below).
- PUSHLOCK Pushlock is to fix the white balance based on the lighting.

RED GAIN

0 ~ 255 Adjusts the amount of red in the image.

BLUE GAIN

0 ~ 255 Adjust the amount of blue in the image.

COLOR MODE

- NORMAL Color is similar to actual color.
- COOL Color has more blue.
- WARM Color has more red.

EXIT JUMP

- SAVE & EXIT Save the current settings and exit the OSD menu.
- EXIT Exit the OSD menu without saving the changes.



DAY & NIGHT

D&N MODE

AUTO / In AUTO mode, camera switches between day and night automatically depending on light level. Camera will stay in color mode when there is enough light and will switch to B&W at night or other low light environments. If COLOR is selected, camera always stays in day/color mode. If B&W is selected, camera always stays in night/B&W mode.

If AUTO is selected, please define the following settings:

*BURST: If ON is selected, the camera provides a color burst signal in night mode.

*COLOR->B&W: Adjusts the light level at which the camera switches from day (color) to night (B&W) mode. The higher the number, the lower the light level.

*B&W->COLOR: Adjusts the light level at which the camera switches from night (B&W) to day (color) mode. This number should be lower than the value of COLOR->B&W above.

*READ TIME: 3s~12s. Time interval delay before switching from day mode to night mode.

*EX_IR INT.: AUTO/EXT. If using IR LEDs built into the camera, select AUTO. If using external IR LEDs separately, select EXT.

NIGHT C.

0 ~ 100 Color will be reduced in low light conditions. (This level cannot be adjusted when 3D-DNR is ON.)

NIGHT A.

0 ~ 100 Edge sharpness will be reduced in low light conditions. (This level cannot be adjusted when 3D-DNR is ON.)

EXIT JUMP

SAVE & EXIT Save the current settings and exit the OSD menu.

EXIT Exit the OSD menu without saving the changes.



FUNCTION

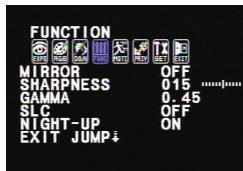

MIRROR

OFF

MIRROR Flips the image horizontally.

SHARPNESS

0 ~ 30

Sets the image sharpness. The higher the number, the sharper the image.

GAMMA

0.45 / 0.60 / Select the desired gamma level. 0.45 is default setting.

1.0 / MANUAL

SLC (SIDE LIGHT COMPENSATION)

OFF / ON Increase the brightness on sides of the image.

NIGHT-UP

OFF / ON Adjusts sensitivity in low light conditions by setup level. If ON is selected, the setup level becomes higher, and the images become brighter.

EXIT JUMP

SAVE & EXIT Save the current settings and exit the OSD menu.

EXIT Exit the OSD menu without saving the changes.



MOTION

The camera can detect the movement and display an alarm on the screen when movement is detected.



AREA SET

AREA 1~4 If ON, motion areas can be selected and moved accordingly. Select Areas 1-4 and adjust using controls for TOP, BOTTOM, LEFT, or RIGHT.

SENSITIV.

1~30 Sensitivity level of the motion detection is adjustable. Motion Detection will be more sensitive at a higher number.

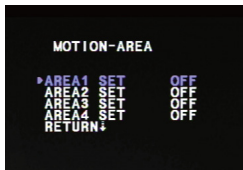

SHOW INDI.

OFF / ICON Set the Show Indicator to OFF, ICON, or TRACE. If ICON is selected, a bell will appear in the upper right hand corner when motion is detected. If TRACE is selected, the area where motion was detected will be highlighted.



EXTER OUT (ALARM SIGNAL, EXTERNAL OUTPUT)

OFF / ON If ON is selected, you can set how long (0~15s) the alarm is displayed on the screen when motion is detected.

EXIT JUMP

SAVE & EXIT Save the current settings and exit the OSD menu.

EXIT Exit the OSD menu without saving the changes.



PRIVACY



You can hide some parts of the screen for privacy masking.
A total of 8 different privacy masking zones are available.

MASK 1 ~ MASK 8

OFF / ON Select ON or OFF for each mask (MASK 1 through 8).

If ON is selected you can set the area to be masked and the shape and color of the mask.

*START POINT: Select the START POINT to adjust the size of the privacy zone.

L_TOP (Left Top)

R_TOP (Right Top)

L_BOT (Left Bottom)

R_BOT (Right Bottom)

*MODIFY: After selecting the START POINT, you can modify the size of the privacy zone by moving the joystick left or right.

*POSITION: You can move the privacy zone by moving the joystick left or right.

*COLOR SET:

Privacy zones can be set with eight different colors - GRAY, BLACK, WHITE, RED, GREEN, BLUE, MAGENTA, and CYAN.





SETUP

TITLE

OFF / ON If ON is selected, you can display the camera title on the screen.

*CLR: Clear the title.

*POS: Position the title on the screen.



DPC (DEAD PIXEL CANCELLATION)

OFF DPC automatically removes defective pixels in real time.

AUTO If AUTO is selected, you can define the following settings:

*WHITE THR: Cancels the white defective pixels.

*BLACK THR: Cancels the black defective pixels.

*DPC LEVEL: Adjusts the sensitivity level of the dead pixel cancellation.

NOTE: Adjust the WHITE THR/BLACK THR and DPC LEVEL at the same time.

MONITOR

MODE 1-2 MODE 1 is the default. If the displayed image is not good enough, try MODE 2.



SETUP

LANGUAGE

The camera supports the following languages: ENGLISH, CANTONESE, MANDARIN, JAPANESE, GERMAN, FRENCH, ITALIAN, RUSSIAN, SPANISH, AND DUTCH.

OSD COLOR

The following colors are available for the OSD menu: BLUE, GREEN, CYAN, RED, MAGENTA, YELLOW, PURPLE, and GRAY.

COMMUNICATION



OFF
ON

If ON is selected, you can define the following:

*PROTOCOL: PELCO-D only.

*CAMERA ID: Provide an ID number for the camera (0~255).

*BAUDRATE: 9600bps is the default. There are four options: 2400bps, 4800bps, 9600bps, and 19200bps.

FACTORY SET

If selected, the camera reverts back to factory default settings.

NOTE: FACTORY SET does not affect the LENS, DAY & NIGHT, CAMERA ID, and DPC SETTINGS.

EXIT JUMP

SAVE & EXIT Save the current settings and exit the OSD menu.

EXIT Exit the OSD menu without saving the changes.



EXIT

EXIT

SAVE & EXIT Save the current settings and exit the OSD menu.

EXIT Exit the OSD menu without saving the changes.

REMOTE CONTROL*

To use the remote controller, set the CAMERA ID in the camera's OSD menu. The default setting is 001.

If the CAMERA ID is modified, user must restart the camera; then the camera will be able to recognize the new ID.

Input the ID number of your camera to the remote controller. After you input the ID number, LED light will turn on, and your remote controller will be ready to be used.

Press KEY + ID Button to access the camera. ① = Camera ID 001.

Press ⑤ ENTER button to access the Menu.

The KEY button will turn the camera into the standby image.

The LED will flicker for 20 seconds.

ZOOM IN (+) / ZOOM OUT (-) Buttons: These are used to control the lens zoom and to select the zooming area of the alarm feature.

Select the area you wish to zoom into during motion, and then select the zoom range, using the ⑦ WIDE button. Select ⑧ TELE button to save the zoom range setting. If the zoom range during motion is smaller than the zoom range during standby, alarm zoom range will not be saved.

To turn on the Alarm feature, select ⑨ ON/OFF button. When the button is selected, the camera will zoom from tele to wide once before the feature turns on. To turn OFF the Alarm feature, select ⑨ ON/OFF button again.

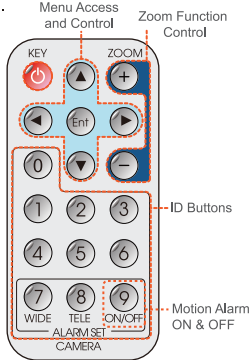

TROUBLESHOOTING

Before sending your camera for repair, check the following or contact our technical specialist.

FOR NO VIDEO

Check the coaxial cable and make sure it is connected securely.

Check the lens' iris adjustment at the camera's OSD menu.

Check the power supply and make sure the camera has the proper voltage and current.

FOR OUT-OF-FOCUS VIDEO

Check the clear dome cover and the lens for dirt or fingerprints. Use a soft cloth and gently clean. Check the lens' manual focal and zoom adjustment. The use of a field test monitor is recommended.



WARRANTY INFORMATION*

Digital Watchdog (referred to as “the Warrantor”) warrants the Digital Watchdog Camera against defects in materials or workmanship as follows:

LABOR: For the initial five (5) years and one (1) year on IR LED from the original purchase date, if the camera is determined to be defective, the Warrantor will repair or replace the unit with a new or refurbished product at its option at no charge.

PARTS: In addition, the Warrantor will supply replacement parts for the initial five (5) years and one (1) year on IR LED.

To obtain warranty or out of warranty service, please contact a Technical Support Representative at **1-866-446-3595** Monday through Friday from 8:30AM to 8:00PM Eastern Standard Time.

A purchase receipt or other proof of the original purchase date is required before warranty service is rendered. This warranty only covers failures due to defects in materials and workmanship which arise during normal use. This warranty does not cover damage which occurs in shipment or failures which are caused by products not supplied by the Warrantor or failures which result from accident, misuse, abuse, neglect, mishandling, misapplication, alteration, modification, faulty installation, set-up adjustments, improper antenna, inadequate signal pickup, maladjustment of consumer controls, improper operation, power line surge, improper voltage supply, lightning damage, rental use of the product or service by anyone other than an authorized repair facility or damage that is attributable to acts of God.

LIMITS & EXCLUSIONS*

There are no express warranties except as listed. The warrantor will not be liable for incidental or consequential damages (including damage to recording media without limitation) resulting from the use of these products or arising out of any breach of the warranty. All express and implied warranties, including the warranties of merchantability and fitness for particular purpose, are limited to the applicable warranty period set forth above.

Some states do not allow the exclusion or limitation of incidental or consequential damages, or limitations on how long an implied warranty lasts, so the exclusions or limitations listed above may not apply to you. This warranty gives you specific legal rights, and you may also have other rights that vary from state-to-state.

If the problem is not handled to your satisfaction, then write to the following address:

Digital Watchdog, Inc.
ATTN: RMA Department
5436 W. Crenshaw Street
Tampa, FL 33634

Service calls which do not involve defective materials or workmanship as determined by the Warrantor, in its sole discretion, are not covered. Costs of such service calls are the responsibility of the purchaser.

SPECIFICATIONS*

DWC-D2382TIR	
VIDEO	
Image Sensor	1/3" Sony Super HAD CCD II
Total Pixels	811 (H) x 508 (V), 411K Pixels
Effective Pixels	768 (H) x 494 (V)
Frequency	15.734KHz (H), 59.95Hz (V)
Synchronization	Internal or Line Lock
Horizontal Resolution	620 TV Lines [B&W], 600 TV Lines [Color]
Minimum Illumination	F1.2 (30IRE): 0.14 Lux [Color] F1.2 (30IRE): 0.0 Lux [B&W]
S/N Ratio	50dB (AGC off)
Video Output	CVBS: 1.0Vp-p / 75 Ω
LENS	
Focal Length	2.9-8.5mm
Lens Type	OMNI-Focus, Auto Iris
IR Distance	70ft Range IR
OPERATIONAL	
Day & Night	TDN with IR Cut Filter
3D-DNR	OFF / LOW / MID / HIGH / SMART
Backlight	OFF / BLC / HME / WDR
Privacy Zones	OFF / ON (8 Programmable Zones)
Language	ENGLISH / MANDARIN / CANTONESE / JAPANESE / GERMAN / FRENCH / ITALIAN / RUSSIAN / SPANISH / DUTCH

ENVIRONMENTAL

Operating Temperature	-10°C ~ 55°C (14°F ~ 131°F)
Operating Humidity	Less than 90% (Non-Condensing)
Storage Temperature	-20°C ~ 70°C (-4°F ~ 158°F)

ELECTRICAL

Power Requirement	Dual (12VDC & 24VAC)
Power Consumption	12VDC: 1.8, 150mA / LED ON 4.6W, 383.3mA 24VAC: 2.4W, 100mA / LED ON 4.9W, 204mA

MECHANICAL

Housing Material	Plastic
Dome Cover Material	Polycarbonate
Dimensions	Ø134.9 X 110.3 mm (Ø5.31 X 4.34 in)
Weight	1.3 lbs

*Specification is subject to change without prior notice.

MEMO*



Everything's Digital

5436 W Crenshaw St. Tampa, FL 33634

Tel : 866-446-3595 / 813-888-9555

Fax : 813-888-9262

www.Digital-Watchdog.com

technicalsupport@dwcc.tv

Technical Support Hours : Monday-Friday

8:30am to 8:00pm EST