

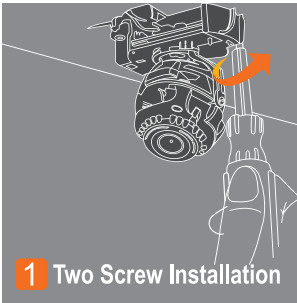

*It's quick. It's easy!*

**Snapit**

Easy Installation 1 2 3



1 Two Screw Installation

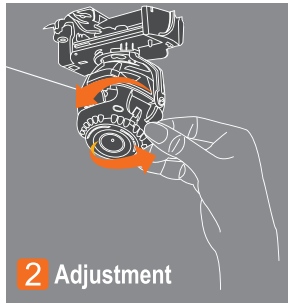

2 Adjustment

Completing your installations quickly is a Snap!

# Indoor Dome Camera D4363DB

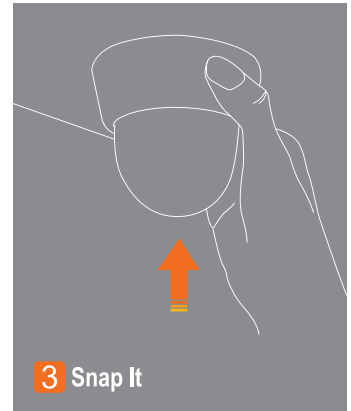

3 Snap It



# STAR-LIGHT™

## Icon Driven OSD Menu

ICON Driven OSD Menu will easily guide you through programming options. Simple and fast programming.

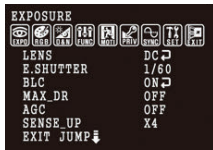

## HME (Highlight Masking Exposure)

Masks overly exposed light to produce a true video image of any environment.



## Smart DNR (Digital Noise Reduction)

Smart DNR produces less noise and more color at night without image lagging.

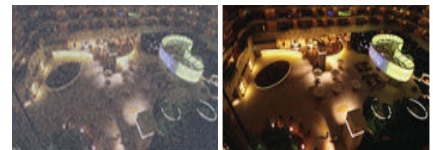

## DRC (Dynamic Range Compressor)

With the advanced light compensation technology DRC, dark spots in images particularly become more visible without overexposing the bright spots to create one perfect image.



## Star-Light (Super Low Light Technology)

Offers a slow shutter feature that increases the length of time the shutter remains open to collect additional light, illuminating typically dark environments.



## Programmable Privacy Zone

When privacy is a concern, monitoring can be masked in certain zones within the scene. The user can define up to eight rectangular exclusions.





**Snapit**  
RS485 UTP



### Dimensions (unit : mm)

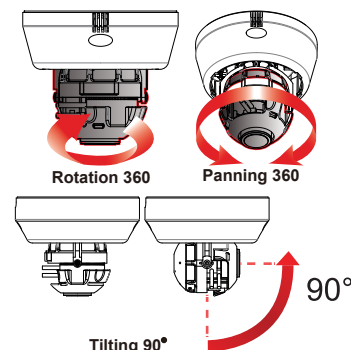
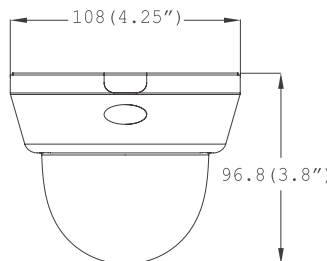

### Snapit Easy Installation 1 2 3

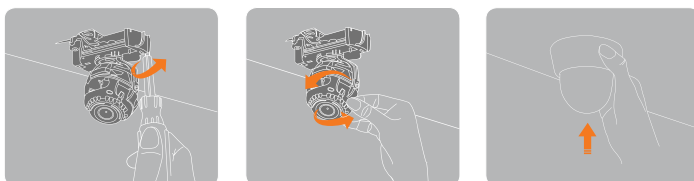

**1 Two Screw Installation**      **2 Adjustment**      **3 Snap It**

### Summary

Our Snapit Indoor Dome D4363DB is powered by our Star-Light technology, which offers super low light imaging for any application. Along with Smart DNR, our Star-Light technology offers a slow shutter feature that increases the length of time the shutter remains open to collect additional ambient light, illuminating typically dark environments.

Our simple to install housing series combined with our reliable camera technology series gives you a high quality camera in just a few minutes. All Snapit housings include both a built-in UTP and RS-485.

### Features

- 1/3" CCD
- 620 TV Lines [B&W], 600 TV Lines [Color]
- 3.3~12mm Varifocal Auto Iris Lens
- Electronic Day and Night
- Smart DNR (Digital Noise Reduction)
- DRC (Dynamic Range Compressor)
- Star-Light (Super Low Light Technology)
- HME (Highlight Masking Exposure)
- Programmable Privacy Zones (8) & Motion Detection
- AGC / BLC / AWB
- Easy Icon Driven OSD Menu with Built-in Joystick
- UTP & RS-485 Built-in
- Auto Sensing 24VAC/12VDC with Line Lock
- Secondary Video-BNC Output
- Black Housing

### Accessories (Optional)



DWC-D1WM  
Wall Mount for D1 & D4 Housing

### Specifications

VIDEO	
Image Sensor	1/3" CCD
Total Pixels	811 (H) x 508 (V), 411K Pixels
Effective Pixels	768 (H) x 494 (V)
Frequency	15.734KHz (H), 59.95Hz (V)
Synchronization	Internal or Line Lock
Horizontal Resolution	620 TV Lines [B&W], 600 TV Lines [Color]
Minimum Illumination	F1.2 (30IRE): 0.14 Lux [Color] F1.2 (30IRE): 0.03 Lux [B&W]
S/N Ratio	50dB (AGC off)
Video Output	CVBS: 1.0Vp-p / 75 Ω
LENS	
Focal Length	3.3-12mm
Lens Type	DC Auto Iris
OPERATIONAL	
Back Light	OFF / BLC / HME / DRC
Star-Light	OFF / X2-X1024
3D Digital Noise Reduction	OFF / LOW / MID / HIGH / SMART
White Balance	AWC / ATW / MANUAL / PUSHLOCK
Mirror	OFF / MIRROR
Sharpness	0-30
Gamma	MANUAL / 0.45 / 0.60 / 1.0
Side Light Compensation	OFF / ON
Night Up	OFF / ON
Motion Detection	OFF / ON (4 Areas)
Privacy Zones	OFF / ON (8 Programmable Zones)
Dead Pixel Cancellation	OFF / AUTO
Language	ENGLISH / MANDARIN / CANTONESE / JAPANESE / GERMAN / FRENCH / ITALIAN / RUSSIAN / SPANISH / DUTCH
ENVIRONMENTAL	
Operating Temperature	-10°C ~ 55°C (14°F ~ 131°F)
Operating Humidity	Less than 90% (Non-Condensing)
Storage Temperature	-20°C ~ 70°C (-4°F ~ 158°F)
ELECTRICAL	
Power Requirement	Dual (12VDC & 24VAC)
Power Consumption	12VDC: 2.3W, 192mA 24VAC: 2.5W, 104mA
MECHANICAL	
Housing Material	Plastic
Dome Cover Material	Polycarbonate
Dimensions	∅108 X 96.8 mm (∅4.25 X 3.81 in)
Weight	0.507 lbs

\*Specification is subject to change without prior notice.