

DW DIGITAL WATCH-DOG



*It's quick. It's easy!*

**Snapit**

Easy Installation 1 2 3

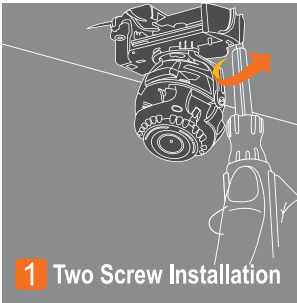

1 Two Screw Installation

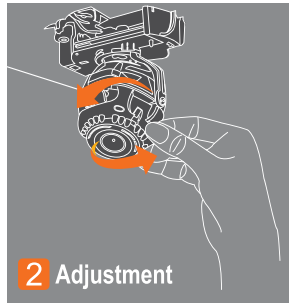

2 Adjustment

Completing your installations quickly is a Snap!

# Indoor Dome Camera D4365T

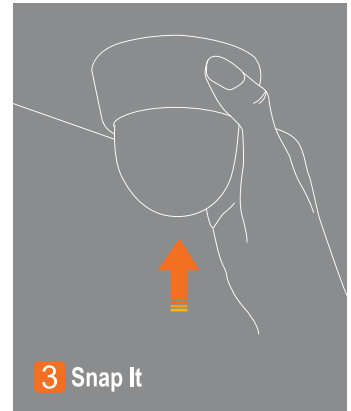

3 Snap It

DW DIGITAL WATCHDOG  
Everything's Digital

**PIXIM**  
RS485 UTP



# PIXIM

## Icon Driven OSD Menu

ICON Driven OSD Menu will easily guide you through programming options. Simple and fast programming.



## Smart DNR (Digital Noise Reduction)

Smart DNR produces less noise and more color at night without image lagging.

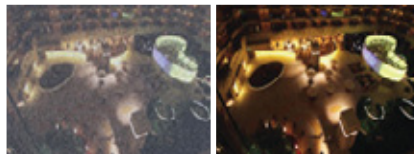

## Programmable Privacy Zone

When privacy is a concern, monitoring can be masked in certain zones within the scene. The user can define up to eight rectangular exclusions.



## Powerful WDR (Overexposure Elimination)

Eliminates overexposure to capture all the details of the scene.



## Powerful WDR (Underexposure Elimination)

Eliminates underexposure to capture all the details of the scene.

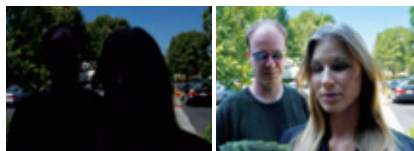

## Smear Canceling Circuit

Eliminates glares and reflections from the video images.





## Dimensions [unit : mm(in)]

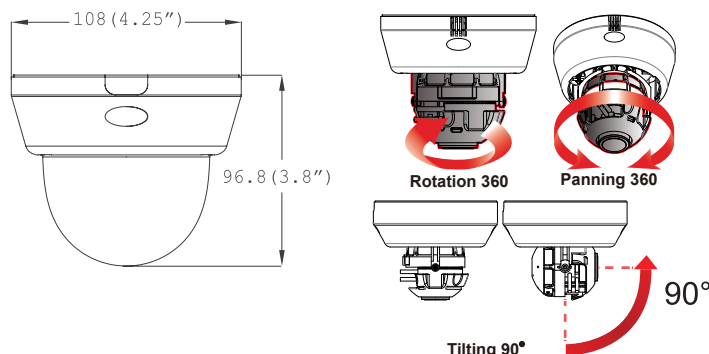

## Snapit Easy Installation 1 2 3

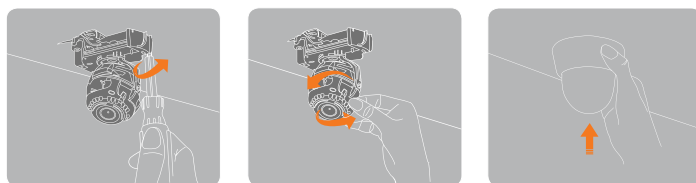

1 Two Screw Installation      2 Adjustment      3 Snap It

## Summary

Our Snapit Indoor Dome D4365T is a high performance camera offering exceptional Wide Dynamic Range, sensitivity to harsh lighting, as well as high resolution imaging with its 1/3" PIXIM Nightwolf CMOS Sensor. PIXIM's technology allows each pixel to self-adjust in the same scene, giving terrific image quality. PIXIM revolutionizes the way video cameras capture and process images. Our simple to install housing series combined with our reliable camera technology series gives you a high quality camera in just a few minutes. All Snapit housings include both a built-in UTP and RS-485.

## Features

- 1/3" PIXIM Nightwolf CMOS Sensor
- 690 Horizontal TV Lines
- 3.3~12mm Varifocal Auto Iris Lens
- TDN (True Day and Night / IR Cut Filter)
- 3D DNR (Digital Noise Reduction)
- Powerful Wide Dynamic Range
- Star-Light (Super Low Light Technology)
- 8X Digital Zoom
- Ultra Low Light Sensitivity
- Smear Cancellation
- Low Power Consumption
- Programmable Privacy Zones (6) & Motion Detection
- UTP & RS485 Built-In
- Auto Sensing 12VDC or 24VAC with Line Lock
- Secondary Video-BNC Output

## Accessories (Optional)



DWC-D1WM  
Wall Mount for D1 & D4 Housing

## Specifications

VIDEO	
Image Sensor	1/3" PIXIM Nightwolf CMOS Sensor
Total Pixels	768 (H) x 548 (V)
Scanning System	525 Lines, 2 : 1 Interlace
Frequency	15.734KHz (H), 59.95Hz (V)
Synchronization	Internal / Line Lock
Horizontal Resolution	690 Effective Horizontal TV Lines
Minimum Illumination	F1.2 (30IRE): 0.22Lux [Color] F1.2 (30IRE): 0.01 Lux [B&W]
S/N Ratio	50dB (AGC off)
Video Output	CVBS: 1.0Vp-p / 75 Ω
LENS	
Focal Length	3.3-12mm
Lens Type	DC Auto Iris
OPERATIONAL	
Lens	MANUAL / DC
AE Preference	OUTDOOR / INDOOR
Back Light Compensation	OFF / ON
Wide Dynamic Range	LOW / NORMAL / MEDIUM / HIGH / CUSTOM
Auto Gain Control	LOW / MEDIUM / HIGH
Star-Light	OFF, x2-30FPS ~ x64
White Balance Mode	ATW / PUSH-LOK / MANUAL / AWC / NORMAL
Day & Night	AUTO / COLOR / B&W
Mirror	OFF / MIRROR / V-FLIP / ROTATE
Sharpness	-8 ~ 8
3D Digital Noise Reduction	OFF / LOW / MEDIUM / HIGH
Digital Zoom	x1 ~ x8
Privacy Zones	OFF / ON (6 Programmable Zones)
Baudrate	2400 ~ 38500
Protocol	PELCO-D
Language	ENGLISH, DEUTSCH, FRANCAIS, ITALIAN, ESPAÑOL, DUTCH
ENVIRONMENTAL	
Operating Temperature	-10°C ~ 55°C (14°F ~ 131°F)
Operating Humidity	Less than 90% (Non-Condensing)
Storage Temperature	-20°C ~ 70°C (-4°F ~ 158°F)
ELECTRICAL	
Power Requirement	Dual (12VDC & 24VAC)
Power Consumption	12VDC: 2.1W, 175mA 24VAC: 2.2W, 91.7mA
MECHANICAL	
Housing Material	Plastic
Dome Cover Material	Polycarbonate
Dimensions	∅108 X 96.8 mm (∅4.25 X 3.8 in)
Weight	0.507 lbs

\*Specification is subject to change without prior notice.