

# DW-ZA Pro

*User's Manual*



8 Channel DVR

### INSTALLATION & SAFEGUARDS

All the safety and operating instructions should be read before the unit is operated.

#### Environment Condition for Installation

- To prevent electric shock or other hazard, do not expose units to rain, moisture, or dust.
- This unit should be located in an area with low humidity and a minimum of dust..
- Place this unit in a well-ventilated place and do not place heat-generating objects on this unit.
- This unit should not be located in an area where it is likely to be subjected to mechanical shocks.

#### Before You Start

- Ensure the power switch is in the OFF position prior to starting.
- Do not attempt to service this unit yourself as opening or removing covers may expose you to dangerous voltage or other hazards.
- Installation should be performed by qualified service personnel only.
- This unit should be operated only from the type of power source indicated on the manufacturer's label and with the power supply included with the unit.

#### Notice

- Be aware thoroughly about the power connection before installation of the unit.
- Before initial configuration or operation you must first set the TIME/DATE, followed by setting the unit to the FACTORY DEFAULT settings, lastly clearing the HDD. Please follow these steps in order.
- Pull the unit out of record mode prior to cutting power to the unit. Do this by entering the setup menu, followed by switching the unit off. Powering off the unit while writing to the disks can cause critical malfunctions. (ex: Recording Error, Playback Error, System Error)
- When you set the record type, you have to set the Record Configuration and also Schedule Setup. This unit records as per the Record type & Schedule setup.
- The [EMERG] button on the front panel is for emergency record using highest image quality.



The lightning flash with arrowhead symbol within an equilateral triangle is intended to alert the user of this equipment that there are dangerous voltages within the enclosure which may be of sufficient magnitude to constitute a risk of electric shock.



The exclamation point within an equilateral triangle is intended to alert the user to presence of important operating and maintenance(Servicing) instructions in the literature accompanying the appliance.

## Contents

<b>CHAP. 1</b>	<b>Features &amp; Package Contents</b>	<b>4</b>
1-1.	Features	4
1-2.	Package Contents	5
<b>CHAP. 2</b>	<b>Function of Each Button</b>	<b>6</b>
2-1.	Front	6
2-2.	Rear	8
<b>CHAP. 3</b>	<b>Installation</b>	<b>9</b>
3-1.	Installation Configuration	9
3-2.	Detailed Installation	10
1)	Rack Mount	10
2)	HDD (Hard Disk Drive)	10
3)	Camera	11
4)	Monitor	11
5)	Power	11
6)	SPOT, Video Printer	12
7)	Other External Device	12
<b>CHAP. 4</b>	<b>Operation</b>	<b>13</b>
4-1.	System Log-in	13
4-2.	Factory Default	13
4-3.	Display Configuration	14
4-4.	Live View Setup	14
1)	Full / Multiple View	14
2)	View in Sequence	15
3)	PIP View	15
4)	Freeze View	15
5)	Zoom View	15
4-5.	Record	16
4-6.	Playback	16
4-7.	Search	17
4-8.	PTZ Camera Operation	17
4-9.	Data Back-Up	18
4-10.	Audio Operation	19
4-11.	Mouse Operation	19
<b>CHAP. 5</b>	<b>Set Up</b>	<b>22</b>
5-1.	Entering the Menu	22
5-2.	Display Setup	23
1)	Screen Display	23
2)	Monitor Setup	23
5-3.	Configuration	24
1)	HDD Management	24
2)	TIME/DATE Setup	26
3)	Camera Setup	26
4)	Interval Setup	28
5)	Alarm Setup	28

## Contents

6)	Event Popup Setup	-----	28
7)	Buzzer Setup	-----	29
8)	Password Setup	-----	29
9)	System Information	-----	29
5-4.	Record Setup	-----	30
1)	Record Configuration	-----	30
2)	Schedule Setup	-----	31
3)	Holiday Setup	-----	31
5-5.	Back-Up (CD-R, USB)	-----	32
5-6.	External Device	-----	33
1)	TCP/IP Setup	-----	33
2)	RS-232C Setup	-----	36
3)	Pan Tilt Zoom Setup	-----	36
4)	Spot Monitor Setup	-----	36
5)	Audio Setup	-----	37
6)	Audio Volume Setup	-----	37
7)	Remocon Setup	-----	37
5-7.	Factory Default	-----	38
5-8.	System Info Summary	-----	38
5-9.	Language Setup	-----	38
<b>CHAP. 6</b>	<b>Network Setup</b>	-----	<b>39</b>
6-1.	DVR Network Configuration	-----	39
<b>CHAP. 7</b>	<b>DW Remote Center</b>	-----	<b>43</b>
7-1.	NETWORK SETUP	-----	44
7-2.	DVR CONFIG	-----	45
7-3.	LIVE	-----	46
7-4.	TURBO LIVE	-----	47
7-5.	BACKUP	-----	49
7-6.	BACKUP VIEWER	-----	51
<b>CHAP. 8</b>	<b>Simple DDNS</b>	-----	<b>54</b>
<b>CHAP. 9</b>	<b>Programmers Reference</b>	-----	<b>57</b>
<b>CHAP.10</b>	<b>Specification</b>	-----	<b>59</b>

## CHAP. 1 Features & Package Contents

### 1-1. Features

#### Live View

Real time display per camera  
Auto Sequence  
PIP (Picture in picture)  
Event Popup  
Digital Zoom  
Display Freeze  
Simple Playback mode  
Simple PTZ camera control

#### Record

Variable Record resolution (For higher picture quality or higher recording speed)  
Efficient Image Quality setup in 5 steps  
Schedule Record / Holiday Record  
Event Record (Alarm / Motion)  
Emergency Record

#### Network

Simple DDNS  
View Live and Playback images across IP network  
(Turbo Live view by H.264 compression)  
Copy images across the network  
Network Video Server

#### Playback

Search & Playback by Date/Time, Event and Camera  
Outstanding picture quality by JPEG 2000 compression algorithm (No mosaic effect)  
Suitable for recording not only images but also text  
Various steps in Forward Playback Speed  
Various steps in Backward Playback Speed  
Easy and convenient search by Jog Shuttle & Remote Controller

#### Data Back-Up

Simple Back-Up using built-in CD Recorder (Back-up CD Player included in the package)  
Network Back-Up using Remote Viewer program (Remote Viewer included in the package)  
Supports bigger capacity of SATA HDD  
USB Device Back-Up available

#### Others

Multi-Language  
VGA option board supports both TFT LCD monitor and CRT monitor  
Lock the system by Password  
JOG / SHUTTLE  
PAL/NTSC Auto detection  
Control the unit by using Remote Controller [Normal, Single, Universal]  
Audio recording : IN-4ch, OUT-1ch (mono)  
System Info Summary

1-2. Package Contents

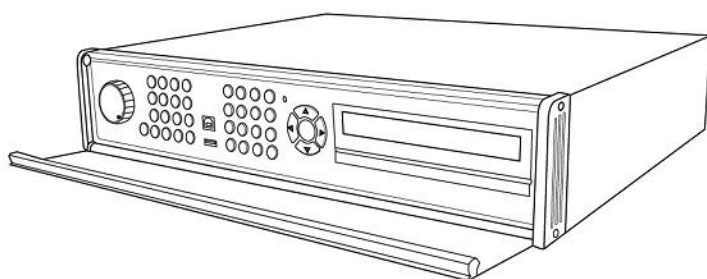

1. DVR Main Unit



2. Remote Controller

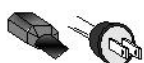

3. Power Cable

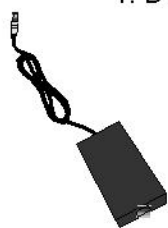

4. Power Adapter

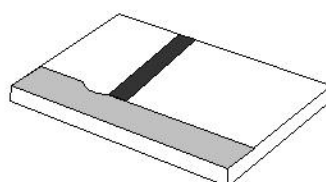

5. User's Manual

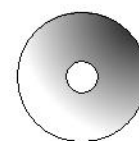

6. Software CD

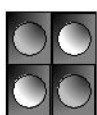

7. Rubber Pad



8. HDD absorber



9. Battery for remote controller

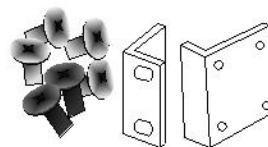

10. Bolts



11. Mouse

Package Contents	Description
1. DVR Main Unit	STAND-ALONE DIGITAL VIDEO RECORDER
2. Remote Controller	DVR control
3. Power Cable	AC power supply to adapters for 12 V DC power
4. Power Adapter	12 V DC power supply
5. User's Manual	User's Manual
6. Software CD	Remote Viewer Software & Back up CD player
7. Rubber Pad	Prevent DVR from slipping. Attach it to the bottom of main unit
8. HDD absorber	Absorbing the mechanical shock of HDD against the case bottom
9. Battery	Battery for remote controller
10. Rack mount bracket / Bolts	Rack mount bracket
	For fixing Rack Mount bracket to DVR (6ea)
	For fixing DVR with Rack Mount bracket to 19" Rack (4ea)
	For fixing Hard Disk Drive into DVR (8ea)
11. Mouse	PS/2 Mouse

CHAP. 2 Function of Each Button

2-1 FRONT

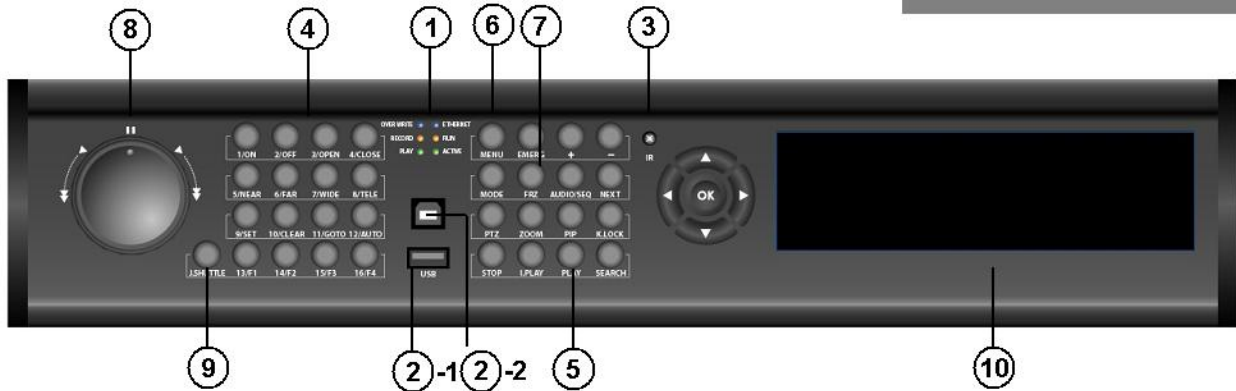

Name	Function	
① LED Lamps	Shows status of operation	
②-1 USB HOST	Back-Up by connecting USB Media to USB HOST	
②-2 USB Device	Firmware upgrade by connecting PC with latest firmware to USB port	
③ IR	IR receiver	
④ Camera selection & PTZ camera control	1. Pressing this button will display a full screen image of that camera	
	2. Control PTZ camera (Each button is assigned for each PTZ command)	
	• ON : LIGHT ON	• SET : SET PRESET
	• OFF : LIGHT OFF	• CLEAR : CLEAR PRESET
	• OPEN : IRIS OPEN	• GOTO : GOTO PRESET
	• CLOSE: IRIS CLOSE	• AUTO : AUTO SCAN
	• NEAR : FOCUS NEAR	• F1 : USER 1
	• FAR : FOCUS FAR	• F2 : USER 2
	• WIDE : ZOOM IN	• F3 : USER 3
• TELE : ZOOM OUT	• F4 : No Functions	
⑤ Record / Playback	EMERG	Emergency Record at continuous, 120ips, SUPER FINE size
	STOP	Stop of Emergency Record and return to Schedule Record from Emergency Record. Playback stop.
	PLAY	Playback of recorded data on HDD
	SEARCH	Search recorded data on HDD
⑥ SETUP	MENU	Set up for SYSTEM MENU or Use to exit the menu Press MENU button before powering off the unit.
	OK (ENTER)	Selects each menu option
	NEXT	Move to next step
	▲▼◀▶	Navigate in the menu
	+ -	Reduce or increase the option value in the menu

## CHAP. 2 Function of Each Button

Name	Function	
⑦ LIVE View Control	PTZ	On/Off for PAN/TILT/ZOOM control mode Press this button first to control PTZ camera connected to DVR unit via RS-485
	ZOOM	Zooming an image
	FRZ	Freezing an image
	MODE	Switch to split display MODE button changes screen-division from (to) full screen to (from) 16-split screen.
	PIP	Display in PIP (Picture in Picture) mode
	AUDIO / SEQ	Press Once, Select audio channel. Press Longer, Auto camera image sequencing in full screen mode.
	K.LOCK	Lock the key function. To unlock, press longer time (for several seconds) and then input the password.
	I. Play (Instant Play)	Playback in backward direction. (in case recorded in continuous mode).
⑧ Jog Shuttle Control	J/SHUTTLE	Pressing Jog Shuttle button (Ready for use Jog/Shuttle) : In playback mode, pressing J. SHUTTLE button make images frozen.
		RUN LED on : While you operate Jog or Shuttle
		ACTIVE LED on : When J. SHUTTLE button is pressed
⑨ Jog Shuttle	Very easy and convenient search : Press J. Shuttle button, and images in playback pause, and then Jog and Shuttle makes it very easy and convenient to search, forward or backward, fast and slow, as user want.	
⑩ CD Recorder (DVD Recorder)	Data Back-up and Firmware Upgrade using built-in CD Recorder	



2-2. REAR

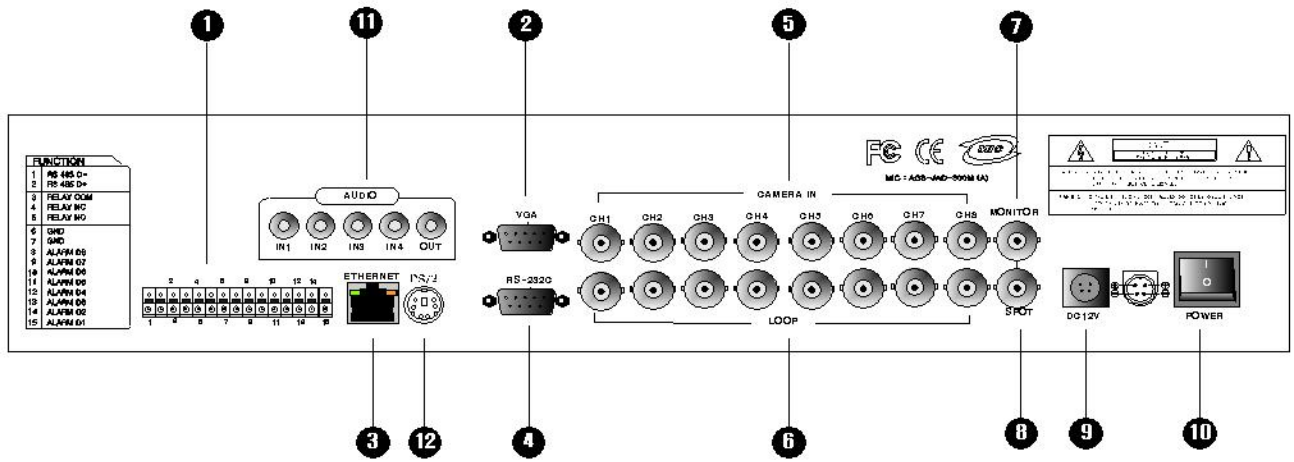

	Name	Function
1	RS 485	Connection with PTZ Camera or other external device using RS 485 interface
	RELAY Output	Relay out terminal
	SENSOR Input	Sensor input terminal
2	VGA	Connection to VGA Monitor (CRT type or TFT LCD monitor) Just in case you purchased DVR with VGA option board fixed on the main board of DVR, you can connect VGA Monitor to DVR unit.
3	ETHERNET	Connection to ETHERNET device
4	RS-232C	Connection to external device as PC using RS-232C to control the DVR
5	CAMERA Input	Connection with camera
6	LOOP Output	Camera loop out
7	MONITOR Output	Connection with Composite Monitor
8	SPOT	Connection with additional composite monitor
9	DC Power	DC 12V 6.67A Adaptor
10	POWER SWITCH	Power ON/OFF switch for adaptors To avoid accidental deletion of HDD data, please make sure to press MENU button and enter into setup menu before powering off the unit. This takes the unit out of record mode for safe shutdown.
11	Audio Input	Microphone Input (4ch)
	Audio Output	Speaker Output (1ch)
12	Mouse	A mouse controlling all functions of DVR

CHAP.3 Installation

3-1. Installation Configuration

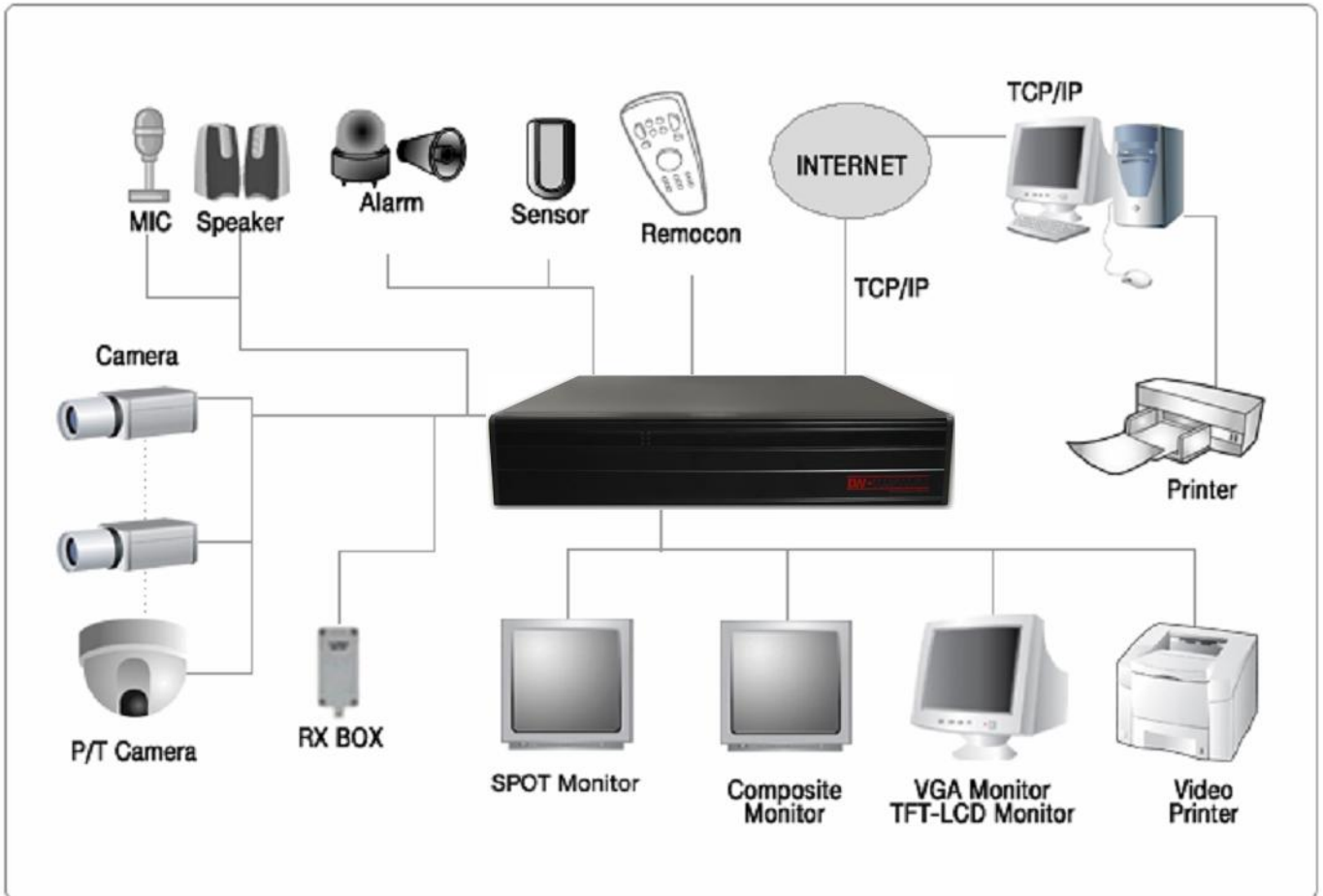

### 3-2. Detailed Installation

#### 1) Rack mount

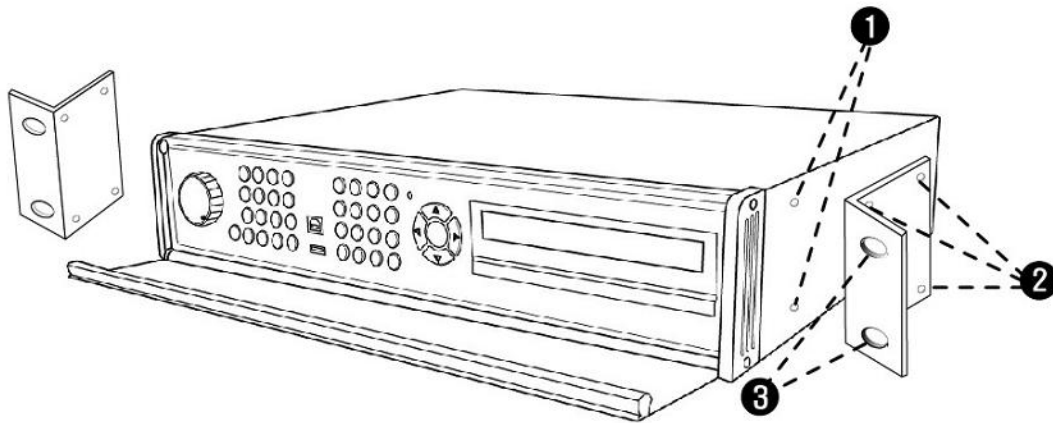

1. Remove 4 bolts on each side cap to install rack mount.
2. Attach rack mount bracket to DVR.
3. Attach DVR with rack mount bracket to 19" rack.

#### 2) HDD

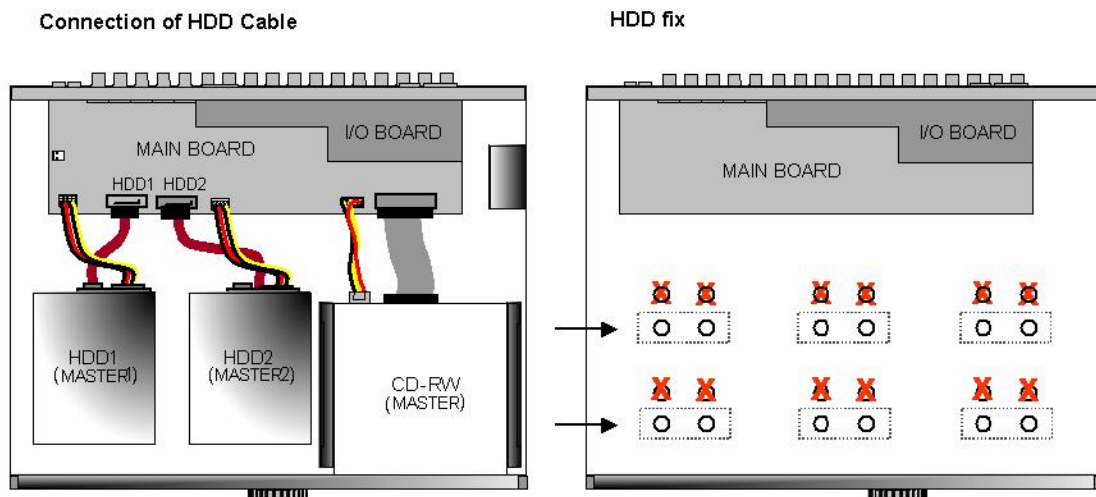

1. Connect Main Board and HDD using SATA DATA cable and HDD power cable.
2. When you use just 1 HDD, install the HDD onto HDD1 location.
3. When you use 2 HDDs, install the first HDD onto HDD1 location and then install the second HDD onto HDD2 location in order.
4. Stick the HDD absorber (included in package) on the bottom of case and then install the HDD on top of them by using the bolts (included in package).
5. Screws must be inserted from outside of the case bottom.

3) Camera

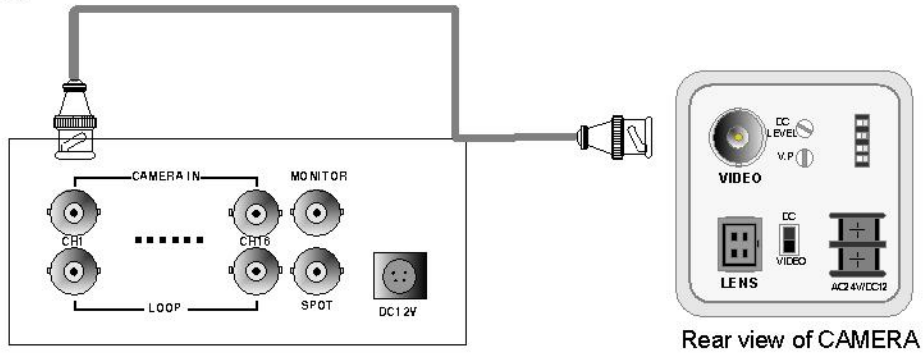

Connect cameras to the camera input on rear panel of DVR marked CAMERA IN.

4) Monitor

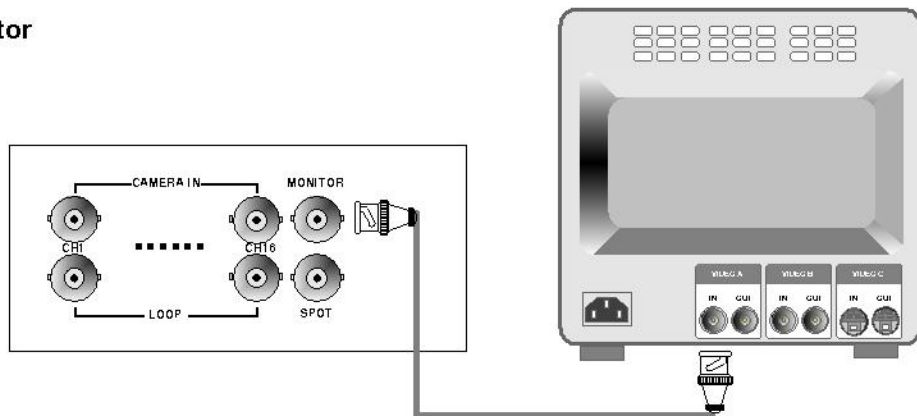

Connect the video output marked MONITOR to Video-In of Main monitor.

5) Power

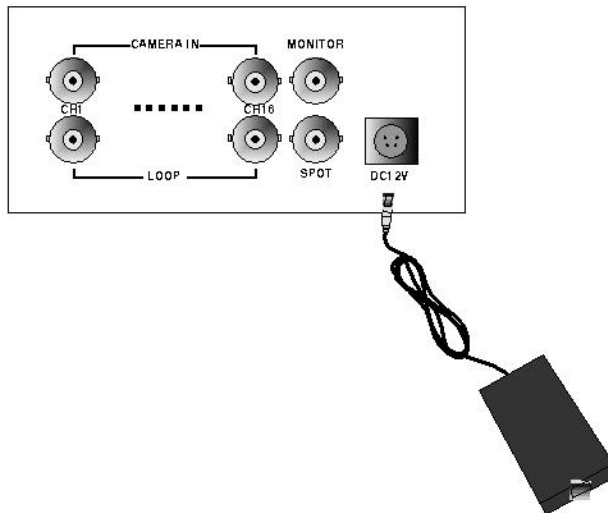

Connect one DC 12V, 6.67 A Adaptor to the back side of Power Jack for right operation of 2HDDs and CD Recorder.



Before you turn on the Power switch, be sure all necessary devices such as Power adaptor, cameras and Monitor are connected properly to DVR!

**Notice**

To avoid accidental deletion of HDD data, please make sure to press MENU button before powering off the unit. This takes the unit out of record mode for safe shutdown.

6) SPOT, VIDEO PRINTER

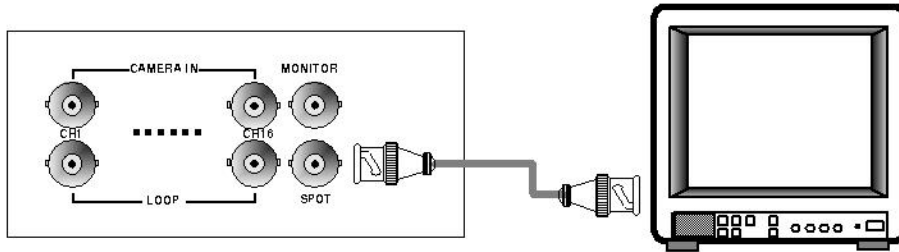

Connection with additional composite monitor

7) Other External Device

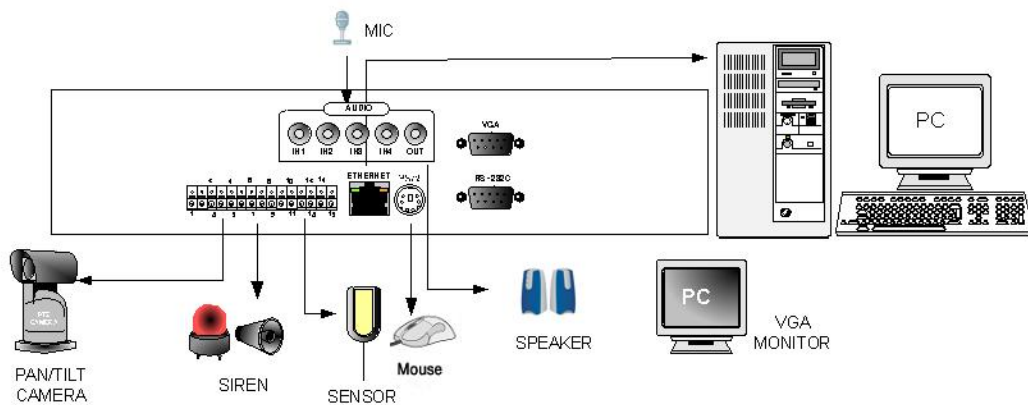

- RS-232C** : Control DVR through RS-232C port by using PC.
- RS-485** : Control external device like PTZ Camera. (Pin No.1 & No.2 at Terminal Block).
- RELAY Output** : Relay Output. (Pin No.3 ~No.5 at Terminal Block)
- SENSOR Input** : SENSOR Input (Alarm connection) – (Pin No.6 ~ No.26 at Terminal Block)
- ETHERNET** : Connection to LAN, WAN, Internet.
- VGA** : Connection to a VGA monitor (CRT,TFT LCD) if optional VGA board is fixed on the main board as shown in the following figure.  
Resolution set by manufacturer is 800x600 60 Hz, and user can set resolution in MONITOR SETUP / VGA SETUP / VGA RESOLUTION.



- Audio Input** : Microphone Input (IN1~IN4)
- Audio Output** : Speaker Output (OUT)

**CHAP. 4 Operation**

**4-1. System Log-In**

- 1) To enter into the setup menu, press the [MENU] button.
- 2) Enter password with channel number button from No.1 to No.10 on the front of the DVR unit. (Maximum of 8 digits are available)
- 3) After inputting the password, press the [←] or [OK] button on the front panel.

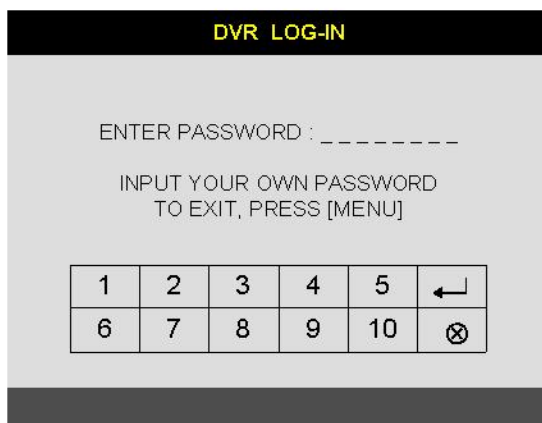

Administrator :

If the password entered matches previously set password, " LOGIN ADMIN" message appears and you can enter into SYSTEM SETUP.

If the password entered does not match previously set password, the DVR unit goes back to live display mode.

Factory default password is blank. For log-in, just press [MENU] button and then [OK] button.

-Factory default password

ADMIN : (Blank)

MANAGER : ' 1 '

USER 1~USER8 : ' 2 ' ~ ' 9 '

※ We recommend configuring a unique password as per the procedure in SYSTEM MENU - CONFIGURATION - PASSWORD SETUP.

※ For security reasons, be sure to make note of your own password.

**4-2. Factory Default**

Before first operation, you must check first if all connected camera images are displayed properly, and then login to the SYSTEM MENU. And you also need to set Time/Date, Factory Default, and then clear HDD. Even though it is brand new one. it is to make DVMR system and HDD ready for proper operation. Starting recording without FACTORY DEFAULT setting and HDD clear will cause malfunction.

**1. FACTORY DEFAULT**

DISPLAY SETUP CONFIGURATION REOCDR SETUP BACK-UP EXTERNAL DEVICE <u>FACTORY DEFAULT</u> LANGUAGE
--

Refer to page 34.

**2. HDD CLEAR**

DISPLAY SETUP CONFIGURATION REOCDR SETUP BACK-UP EXTERNAL DEVICE FACTORY DEFAULT LANGUAGE	<u>HDD MANAGEMENT</u> TIME/DATE SETUP CAMERA SETUP INTERVAL SETUP ALARM SETUP EVENT POPUP SETUP BUZZER SETUP PASSWORD SETUP SYSTEM INFORMATION
---	--

Refer to page 21.

4-3. Display Configuration

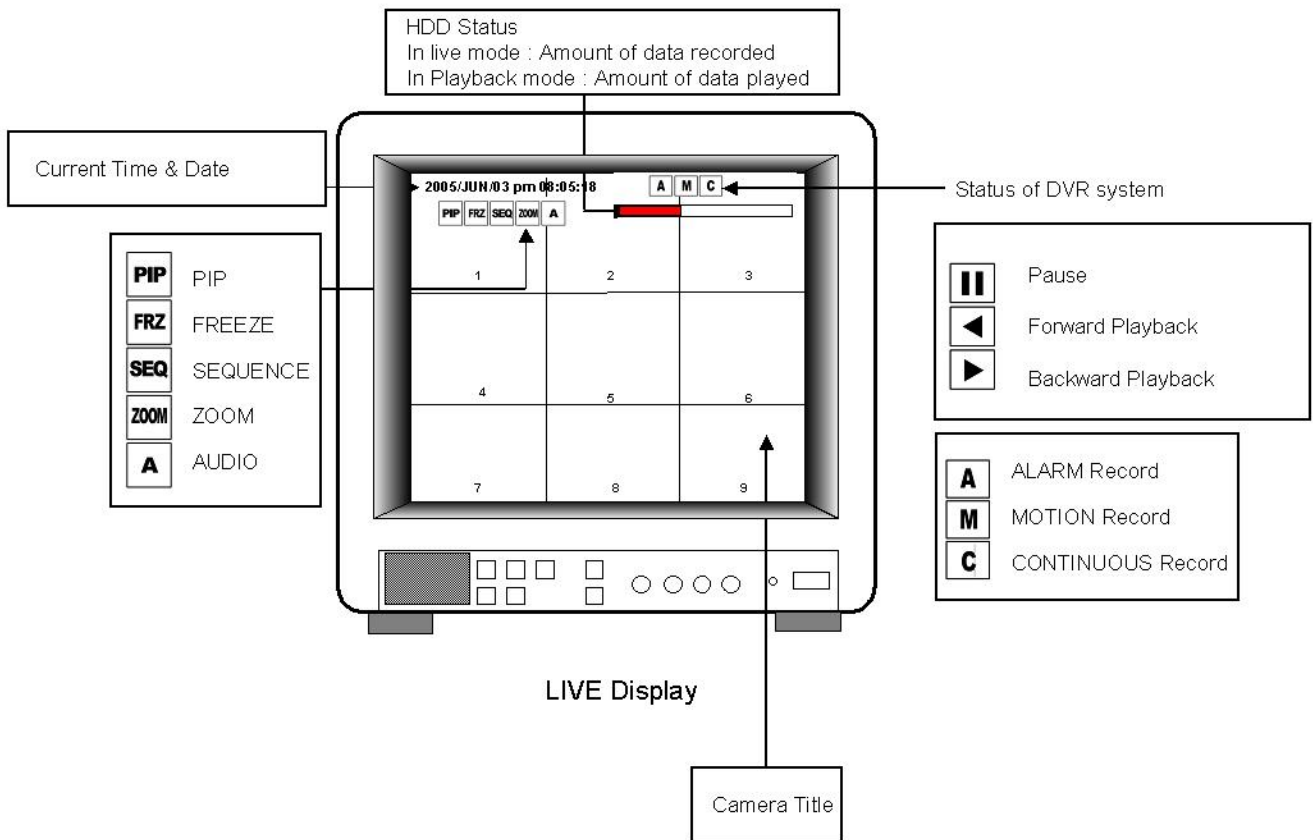

4-4. Live View Setup

1) Full / Multiple View

Switch to multi-screen display by pressing [MODE]. For full image display, just press the channel button which you want or continue to press [MODE] button until you see full screen.

When you playback images which recorded in 360X240(360X288) resolution, only 1, 4, 9, 13 & 16 split screens are available. When you playback images which recorded in 360X120(360X144) resolution, only 1, 4 & 16 split screens are available.

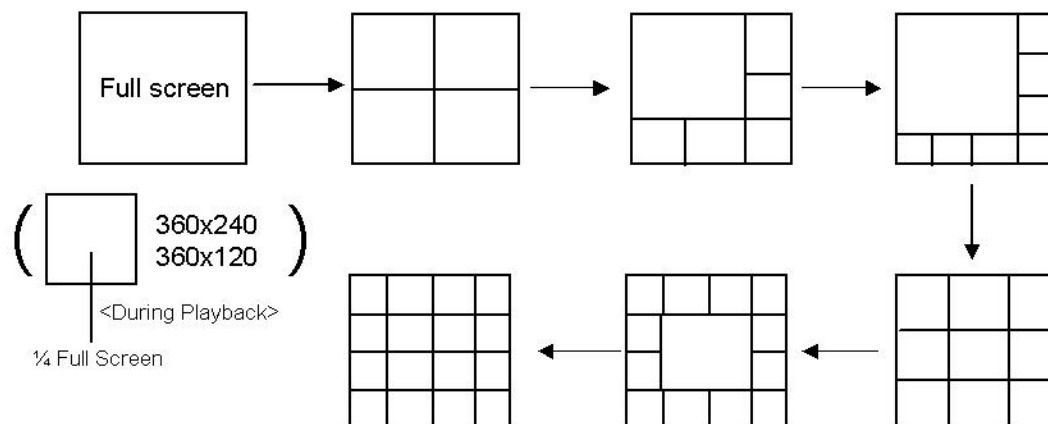

Multiple screen changes

2) View in Sequence

Press [SEQ] button. It automatically displays full screen images in sequence.

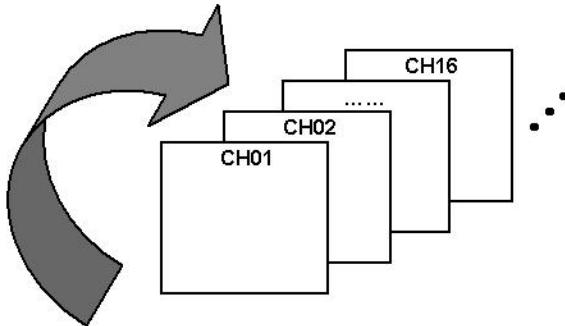

3) Picture in Picture (PIP View)

When it is in full screen display mode, you can see other camera in a small window by pressing [PIP]. The other camera in small window is rotating in sequence to next number of camera and you can set the rotating time interval as per the procedure in SYSTEM MENU-CONFIGURATION-INTERVAL SETUP.

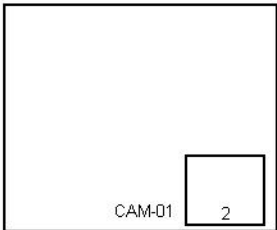

4) Freeze View

Full display mode : If you press the [FRZ] button, the FRZ icon will be activated on the screen and "F" character will be shown beside camera title, and live image will be frozen.  
Split display mode : If you press the [FRZ] button, the FRZ icon will be activated on the screen. press the channel button which you want to freeze.  
To release frozen image, press channel number of frozen image again and press [FRZ] button to exit FRZ mode.

5) Zoom View

In full screen, press the [ZOOM] button and move the Selection Frame using J.SHUTTLE or Direction keys to the area which you want to enlarge. And then press the [OK] button for 2-times enlarged picture. To exit Zoom mode, just press [ZOOM] button again.

Horizontal Movement : J.SHUTTLE  
Vertical Movement : Hold [UP or DOWN] button and turn J/SHUTTLE



**4-5. Record**

Recording mode set before delivery by manufacturer (Default recording mode) is Schedule Recording. In this default recording mode, it records 24 hours/day continuously in weekday and on the weekend. Once you press the [EMERG] button while you see live view, the record type is changed to Emergency Record mode.

- Emergency Record : at full resolution/in best quality  
Record type : CONTINUOUS, SUPER FINE quality,  
120 (100) ips at 720X240 (720x288)
- Schedule Record  
Record and stop as set (time interval and record type) in RECORD-SCHEDULE SETUP menu.
- Stop Record  
Recording stopped as set in RECORD-SCHEDULE SETUP menu.

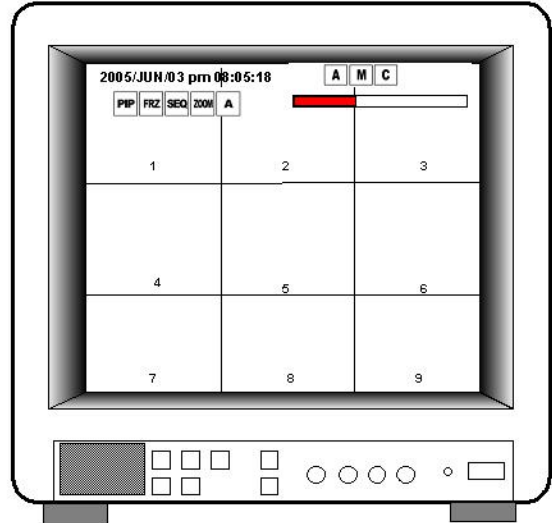

**- This DVR unit does not record in following conditions ;**

- ※ While entered in the Menu.
- ※ No camera is connected
- ※ Overwriting is off in the Record Setup menu. ( HDD full )

**4-6. Playback**

On record mode or stop mode, press [PLAY] button to play the recorded data in 1x speed. For backward playback, press [PLAY] button again. Use Jog/Shuttle to pause and control playback speed. To stop playback, press the [STOP] button.

**Using Jog/Shuttle**

The [ACTIVE] LED will be lit, and Jog/Shuttle is ready for use. The [RUN] LED will blink whenever you operate the Jog/Shuttle.

For forward playback, turn the Shuttle right and turn Shuttle left for backward playback.

Turn Jog using your index figure to see picture by picture in forward or backward direction.

Operation of Shuttle is as follows.

J.SHUTTLE

RUN

ACTIVE

1/4 x : 4 times slower than normal playback speed

1/2 x : 2 times slower than normal playback speed

1 x : Normal playback speed

2 x : 2 times faster than normal playback speed

4 x : 4 times faster than normal playback speed

16 x : 16 times faster than normal playback speed

64 x : 64 times faster than normal playback speed

Backward Playback 32x supportable.

If you want to keep the playback speed you selected using Shuttle, just hold the shuttle at that location for a few seconds, and playback in speed you selected continues until you rotate Shuttle again.

**4-7. Search**

Press [SEARCH] button, and 3 different methods for searching recorded data are available as shown in following SEARCH window. For selecting searching method, use direction key or Jog/Shuttle. After selecting each search method, press [OK] button for playback. exit, press [MENU] button.

1) SEARCH BAR

Search by percentage of total recorded data. It starts from image corresponding to set % of data on the search bar.

2) TIME/DATE

Search by time & date. Playback starts from the time & date selected.

3) EVENT LIST

Search by event list (Motion, Alarm, Video Loss).

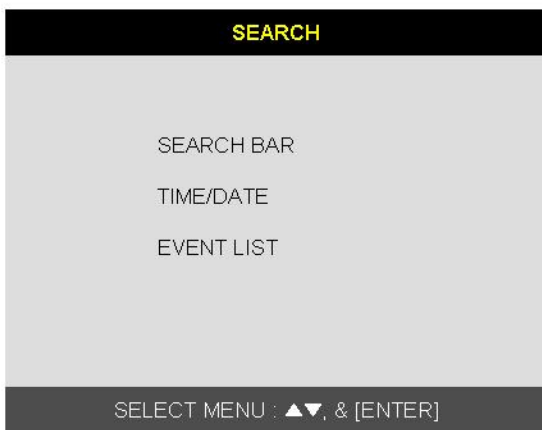

**SEARCH page**



**SEARCH BAR page**



**TIME/DATE page**

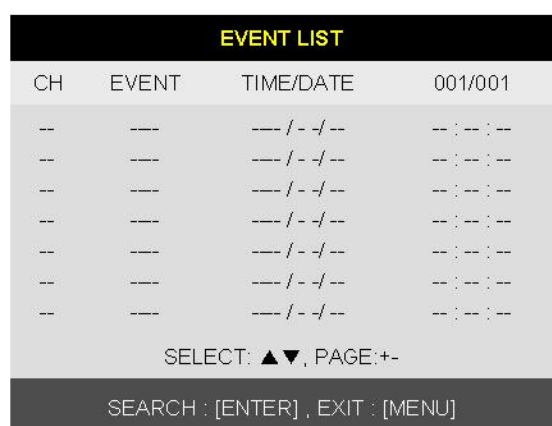

**EVENT LIST page**

**4-8. PAN/TILT/ZOOM Camera Operation**

Press [PTZ] button first for PTZ control mode. Numeric buttons from 1 to 16 and direction buttons are assigned for each PTZ command, and user can control PTZ camera connected to DVR unit by pressing any one of those 20 buttons, one after the other, as needed, and it is just like control by separate PTZ controller.

Button	PTZ command	Button	PTZ command
1/ON	POWER ON	10/CLEAR	PRESET CLEAR
2/OFF	POWER OFF	11/GOTO	PRESET GOTO
3/OPEN	IRIS OPEN	12/AUTO	AUTO SCAN
4/CLOSE	IRIS CLOSE	13/F1 ~ 16/F4	FUNCTION
5/NEAR	FOCUS NEAR	UP BUTTON	TILT UP
6/FAR	FOCUS FAR	DOWN BUTTON	TILT DOWN
7/WIDE	ZOOM IN	LEFT BUTTON	PAN LEFT
8/TELE	ZOOM OUT	RIGHT BUTTON	PAN RIGHT
9/SET	PRESET SET		

#### 4-9. Data Back-Up

Enter into SYSTEM MENU-BACKUP-CD-R SETUP.

- 1) Insert empty CD Recorder media into CD Recorder and select the start time & date from which you want to back up.
  - ※ The START & END time / date in HDD sub-menu only shows start and end of recording. This is not selectable and editable.
  - ※ 700MB on CD Recorder sub-menu represent size of CD Recorder media inserted.
- 2) To set start time of back-up and back-up data size, press the [OK] button first on [START] or [SIZE] sub-menu and adjust using [+] or [-] button and move using [LEFT] and [RIGHT] button for next change. After setting the time & date and back-up data size, press the [OK] button again to exit.
  - ※ End of back-up time will be calculated automatically as per start time & date and the back-up data size you set.
  - ※ User can select the back-up data size (size of back-up data from start of back-up) on [SIZE] item but END of back-up time is automatically determined by DVR system.
- 3) Press [OK] button on BURN sub-menu. DVR system starts burning CD.
- 4) When burning is completed, CD Recorder media will come out automatically. In the next CD back-up, start time of CD Recorder shall be the end time of previous CD-back-up, and you can back-up from that for continuous data back-up. If you need another backup, repeat the above procedure. To stop backup, press the [MENU] button.
  - ※ During burning CD, it's impossible to cancel burning process.
- 5) User can verify the back-up CD on PC with BACK-UP CD PLAYER (Included in Package).

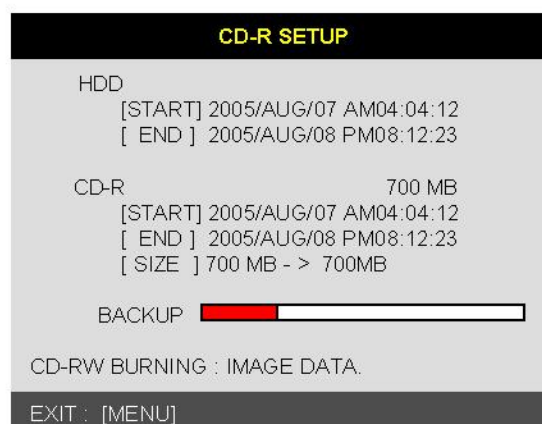
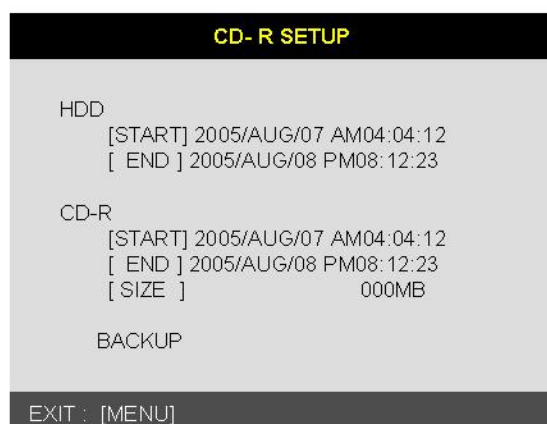

#### 4-10. Audio Operation

Press [AUDIO] button to select audio channel..Ch1, Ch2, Ch3, Ch4 or silence in due sequence.

※ Sound of the selected audio channel comes out in Live display.

Recorded sound comes out in Playback.

#### 4-11. Mouse Operation

##### 1) Basic Operation

There are 11 keys that work by Mouse.

LEFT, RIGHT, WHEEL button Click once, double Click, Click longer.

And WHEEL UP/DOWN.

##### 2) Status that MOUSE ICON is not appeared

- LEFT button - double click : The assigned channel is sequencing to FULL Screen → Left button double click, it reverts to previous split screen.

If user selects FREEZE, the assigned channel FREEZE.

- RIGHT button - double click : The MOUSE ICON will be shown.

- WHEEL button - click longer : Hide MOUSE ICON

- LEFT button - click longer : In ZOOM mode, holding this button will change the icon.  
If User moves the MOUSE, ZOOM area also moves.

##### 3) Working Status in SETUP MENU

- LEFT button click once : OK(ENTER)

- LEFT button double click : NEXT

- LEFT button click longer : MINUS

- WHEEL button click once : MODE (Schedule Recording, MASK SETUP)

- WHEEL button double click : LEFT (For deleting password)

- WHEEL button click longer : None

- WHEEL button upper : PLUS

- WHEEL button lower : MINUS

- RIGHT button click once : MENU

- RIGHT button click longer : PLUS

Basically by Left button to select Menu, and by Right button to exit Menu.

Move mouse up and down, left arrow moving and indicate selected menu items.

WHEEL : to plus/minus Left button : to press enter

And Left key (Wheel button double click) : password deletes one by one (Login).

4) Working Status in LIVE MOUSE ICON

Following is the assigned KEY by each ICON.

ICON	Left Click	Right Click	ICON	Left Click	Right Click
	<b>MENU</b>			<b>NEXT</b>	OK[ENTER]
	<b>PLUS</b>	MINUS		<b>I.PLAY</b>	PLAY
	<b>EMERG(REC)</b>	STOP		<b>PTZ</b>	
	<b>SEARCH</b>			<b>FRZ</b>	
	<b>ZOOM</b>			<b>SEQ</b>	
	<b>PIP</b>			<b>K.LOCK</b>	
	<b>AUDIO</b>				

<LIVE MODE>

5) Working Status in PLAY MOUSE ICON

Mouse working is the same as above LIVE ICON.  
 Place mouse ICON and by Wheel Up/Down button, PLAY SPEED can be controlled.  
 And In Pause condition, place mouse ICON and by Wheel Up/Down, STEP PLAY can be controlled.

Following is the assigned KEY by each ICON.

ICON	Left Click	Right Click	WEEL	ICON	Left Click	Right Click	WEEL
	<b>STOP BACKWARD</b>		Step play		<b>SLOW BACKWARD</b>		
	<b>FAST BACKWARD</b>				<b>PLAY</b>		PLAYBACK SPEED
	<b>FAST FORWARD</b>				<b>SLOW FORWARD</b>		
	<b>STOP PLAY</b>		Step play		<b>PAUSE</b>		
	<b>EMERG(REC)</b>	STOP			<b>ZOOM</b>		
	<b>MENU</b>				<b>AUDIO</b>		

<PLAYBACK MODE>



















6) Working Status in PTZ MOUSE ICON

Mouse working is the same as LIVE ICON.

Place Mouse  ICON , and by Wheel Up/Down, User can change value PRESET,TOUR, GOTO and etc.

For other ICONs, user can change channel by Wheel Up/Down.

Following is the assigned KEY by each ICON.

ICON	Left Click	Right Click	WEEL	ICON	Left Click	Right Click	WEEL
	LEFTUP		Change Channel		UP		Change Channel
	RIGHTUP				LEFT		
	ENTER				RIGHT		
	LEFTDOWN				DOWN		
	RIGHTDOWN				ZOOM IN	OUT	
	FOCUS NEAR	FAR	FOCUS FAR/NEAR		GOTO PRESET		Change Channel
	SET PRESET		Change Channel		PLUS	MINUS	PRESET NUM +/-
	CLEAR PRESET				AUTO SCAN		Change Channel
	PTZ MENU/EXIT				MENU	NEXT	Change Command

7) Working Status in SPLIT MOUSE ICON.

To change assigned screen division, click left button of mouse once.



Please note that specific division can not be supported such as QUAD record/playback.

And according to DVR channel, screen division can be different.

ALL	4CH	6CH	8CH	9CH	13CH	16CH
-----	-----	-----	-----	-----	------	------

8) Working Status in NUMBER MOUSE ICON.

User can use it for KLOCK or LOGIN and change PASSWORD.

1	2	3	4	5	
6	7	8	9	10	

CHAP. 5 Set Up

5-1. Entering into the Menu

Enter into SYSTEM MENU by pressing [MENU] button.

Button	Function
<b>MENU</b>	Enter into SYSTEM MENU, Move to previous menu, ESC
<b>OK</b>	Selection key, Move to sub-menu, change status (ON or OFF)
<b>NEXT</b>	Move to next page
<b>UP</b>	Move to upper side
<b>DOWN</b>	Move down side
<b>LEFT</b>	Move to the left
<b>RIGHT</b>	Move to the right
<b>MINUS [-]</b>	Decrease the option value
<b>PLUS [+]</b>	Increase the option value
<b>Jog Shuttle</b>	Jog left turning : Move backward to next image / Decrease value Jog right turning : Move forward to next image / Increase value
	Shuttle left turning : Decrease playback speed / Decrease value Shuttle right turning : Increase playback speed / Increase value

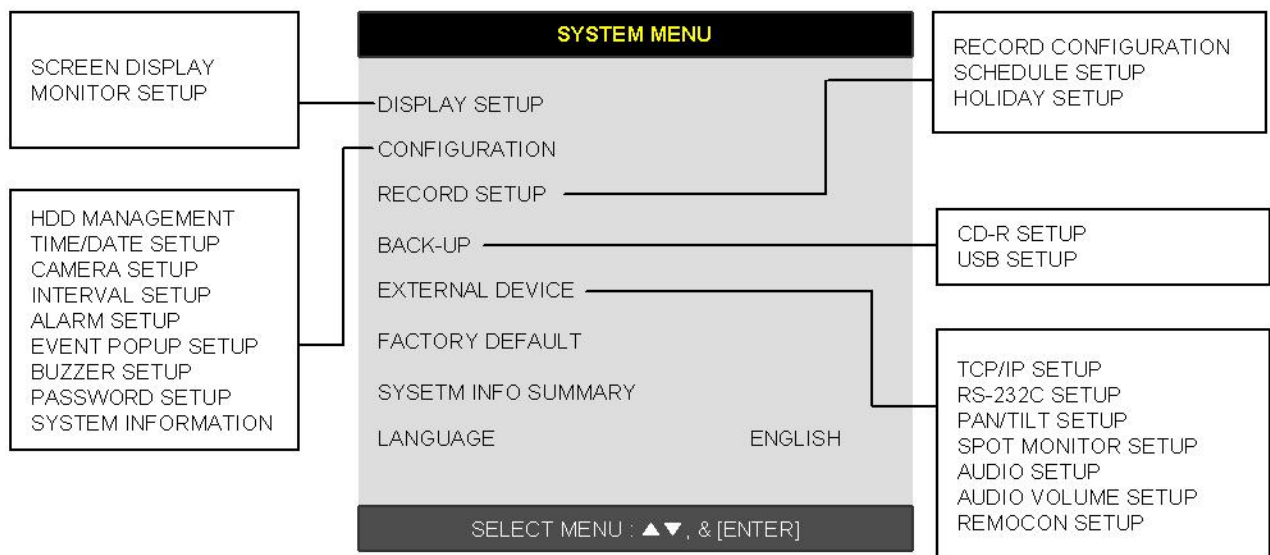

SYSTEM MENU

5-2. DISPLAY SETUP

Setting up parameters for monitor and display on screen.  
Enter into SYSTEM MENU-DISPLAY SETUP.

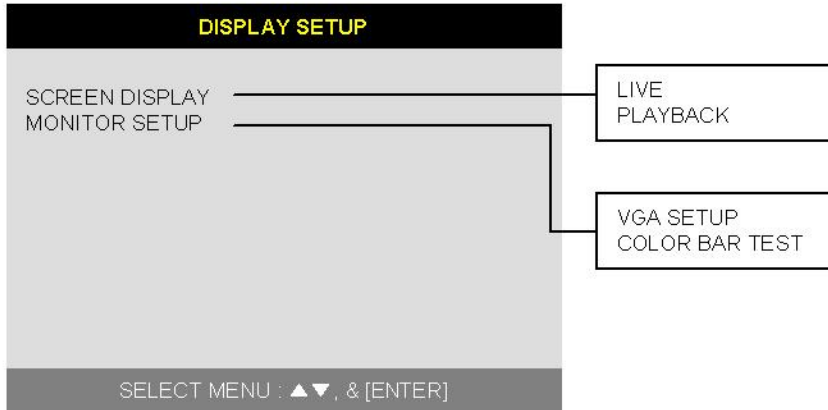

1) SCREEN DISPLAY

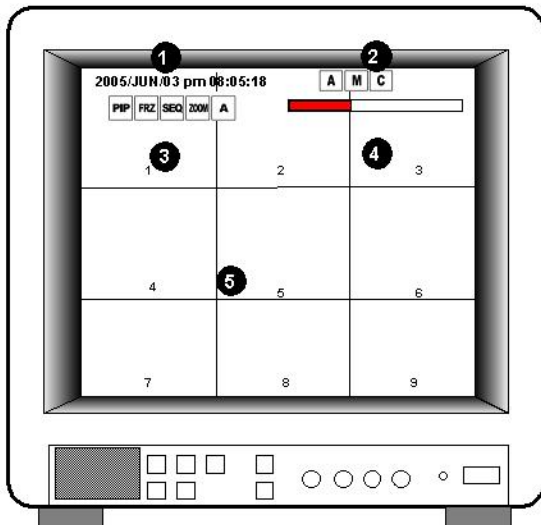

Setting up the screen display in LIVE mode and PLAYBACK mode.

Select the sub-menu which you would like to set using direction buttons and then change ON/OFF with [OK] button.

- 1. TIME/DATE : Display time & date
- 2. DVR STATUS : Display system setting status
- 3. ICON DISPLAY : Display function setting status
- 4. REC/PLAY BAR : Display record / playback status
- 5. CAMERA TITLE : Display camera title

2) MONITOR SETUP

**VGA SETUP :** VGA option card enables to connect TFT LCD monitor or CRT type PC monitor to DVR unit. To connect TFT LCD monitor or CRT type PC monitor to DVR unit, select resolution as follows using [+] or [-] button. After setting the below option, press [ENTER] button then the DVR unit will set VGA resolution automatically.  
VGA option card supports following resolution, and choose best resolution that match TFT LCD monitor or CRT type PC monitor to be connected to DVR unit.

- 640X480 / 60Hz
- 800X600 / 60Hz
- 1024X768 / 60Hz
- 1280X1024 / 60Hz
- 640X480 / 75Hz
- 800X600 / 75Hz
- 1024X768 / 75Hz
- 1280X1024 / 75Hz

※ **NOTICE :** In the booting process, DVR unit with VGA option card takes some seconds more to set parameters.

**COLOR BAR TEST :** Adjust color tone of monitor.  
(Color bar test is Not available for monitor through VGA)



5-3. CONFIGURATION

Various parameters for system can be set in CONFIGURATION menu. Enter into SYSTEM MENU-CONFIGURATION and press the [OK] button.

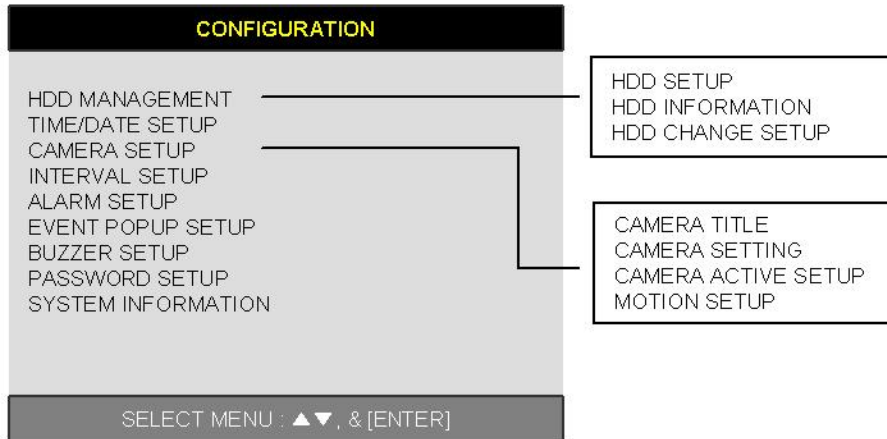

1) HDD MANAGEMENT

Enter into SYSTEM MENU-CONFIGURATION-HDD MANAGEMENT and press the [ENTER] button.

(1) HDD SETUP

This page includes information about start and end of recording, location of recorded data, or location of last playback on HDD. In addition, users can delete all the data on HDD.

HDD SETUP		
STATUS	HDD	DATE/TIME
BEGIN	MASTER-1	2005/04/08 12:12:05
RECORD	MASTER-1	2005/04/09 15:09:58
PLAY	MASTER-1	2005/04/08 19:44:31
HDD STATUS		IN USE
HDD CLEAR		IN USE →

HDD CLEAR [ENTER], EXIT [MENU]

On the [HDD CLEAR] sub-menu, press the [ENTER] button to delete all image data on HDD. The system will ask password for verification. After you clear all data on HDD, status of HDD CLEAR changes from IN USE to EMPTY.  
※ When you clear HDD, event list is deleted, too.

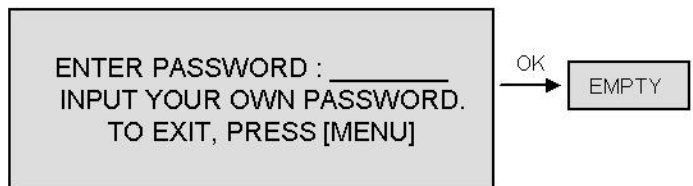

If you selected OVERWRITE in Record Setup, the HDD STATUS presented as OVERWRITE.

(2) HDD INFORMATION

This menu will show the physical information of HDD in DVR.

HDD INFORMATION	
[MASTER-1]	
MODEL	Maxtor 6Y080L0
SPEED	PIO-4
SIZE	81,964,302,336 BYTES
START	2005/04/08 12:08:56
END	2005/04/08 12:08:56
[MASTER-2]	
MODEL	Maxtor 6Y080L0
SPEED	PIO-4
SIZE	81,964,302,336 BYTES
START	2005/04/08 12:08:56
END	2005/04/08 12:08:56

TO EXIT, PRESS [MENU]

(3) HDD CHANGE SETUP

Without losing data, user can use HDD from other DVRs, and HDD installed current DVR can be used to other DVRs.



1) SAVE DVR INFO

Once you press [OK] button on "SAVE DVR INFO" , the DVR information will be saved on HDD. If the DVR information is saved properly, you can see "NOW CHANGE HDDDISK" message on DVR. Then power off the DVR and change with new HDD.

※ NOTICE : Be sure to write down the DVR information as like NTSC/PAL, MODEL name, Channel, HDD location (PORT 1, PORT2). When you want to retrieve the HDD (old), you must do based on this DVR information.

2) LOAD DVR INFO

"LOAD DVR INFO " : it retrieves recorded HDD from other DVR set.

- HDD retrieval procedure

1. Install HDD with new DVR and power on.
2. Press [STOP] button when the DVR is booting.  
(Then, User can see "HDD CHANGE MODE-ON" message.)
3. It retrieves when user executes "LOAD DVR INFO" in Menu.

Please note that if the HDD conditions are changed between backup and retrieval. There are some possibilities losing DATA. So, please remember the condition during backup.

**2) TIME/DATE SETUP**

Set time and date of DVR system which is very important for search with time and date of the event. Time and date set by manufacturer is different from local time of user, and user must set time and date exactly in the first operation. Set time & date using direction buttons and [-][+] button or Jog shuttle

2.Change the date, time and month format for user's convenient

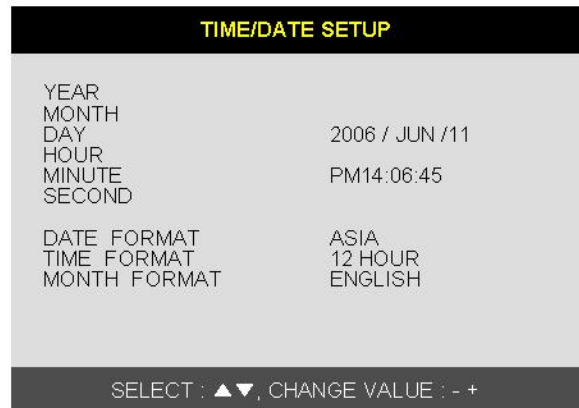

**3) CAMERA SETUP**



(1) TITLE : Input Title of each camera. Move to channel you want to change using [LEFT] or [RIGHT] direction button and then change the title using [-] [+] button. When modification is finished, press the [OK] button. To exit to previous menu, press the [MENU] button.

(2) COLOR : Adjust image color  
Move to each element using [UP][DOWN] button and adjust using [-] [+] button or Jog shuttle.

CHANNEL : Select camera

BRIGHTNESS : Adjust image brightness (-32~ 31)

CONTRAST : Adjust color contrast ( -32 ~ 31)

SATURATION : Adjust color saturation ( -32 ~ 31)

HUE : Adjust color hue ( -32 ~ 31)

CAMERA POSITION : Adjust camera image To the center. If value is lower : Left value is higher : Right (0~80)

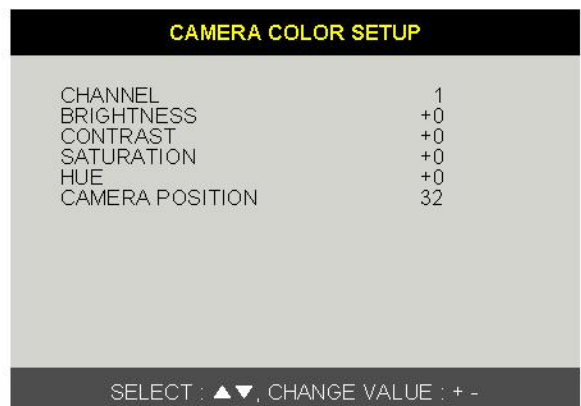

CAMERA ACTIVE SETUP			
CH	STATUS	LIVE	REC
01	ACTIVE	ON	ON
02	ACTIVE	ON	ON
03	LOSS	OFF	OFF
04	ACTIVE	ON	ON
05	ACTIVE	ON	ON
06	ACTIVE	ON	ON
07	LOSS	OFF	OFF
08	ACTIVE	ON	ON

SELECT : ▲▼◀▶, & [ENTER]

MOTION CONFIGURATION	
CHANNEL	01
SENSITIVITY GRADE	01
MOTION DISPLAY TYPE	OFF
RECORD DURATION	05 SEC
NUMBER OF CELL OT DETECT	02

SELECT ▲▼, CHANGE VALUE : + -

(3) CAMERA ACTIVE SETUP : With direction button, move to option to be changed, and press [OK] button to select [ON/OFF]. If it is set at LIVE [OFF] and REC [ON], DVR system records, but does not show live image of set channel.

- STATUS : Shows if image from a specific channel is coming for live display and recording. In normal camera condition, it is ACTIVE, but LOSS is displayed when the cable is disconnected or camera is not working.
- LIVE : Decides whether to show LIVE screen image or not.
- REC : Decides whether to record relevant channel or not.

(4) MOTION SETUP: You can set sensitive of motion detection in 4 steps, motion detection area and others in relation to motion recording in this menu.

(4)-1. MOTION CONFIGURATION

- SENSITIVITY GRADE : Adjusts motion detection sensitivity. (LOW, MEDIUM, HIGH, VERY HIGH)
- MOTION DISPLAY TYPE : Showing cells with motion detected differently from cells with no motion .
- RECORD DURATION : Whenever motion is detected and it is set at Motion Recording mode, DVR system records for RECORD DURATION from time motion is detected. (1sec. ~ 99 sec.) (Default duration : 5 sec.)

(4)-2. MOTION MASK SETUP: Set motion detection area. Direction button is for moving and [OK] button is for selection, and [MODE] button is for changing mode of MASK SETUP.

- CELL : Move to the location which you want to detect and then press the [OK] button. Highlighted cell area means motion detection area.
- ALL ON : Set all cells as detection area. Use [OK] button to set.
- ALL OFF : Set all cells as no-detection area. Use [OK] button to set.
- BLOCK ON : Select detection area by block. Use [MODE] button and press [OK] button to set ON.
- BLOCK OFF : Select un-detection area by block. Use [MODE] button and press [OK] button to set ON.

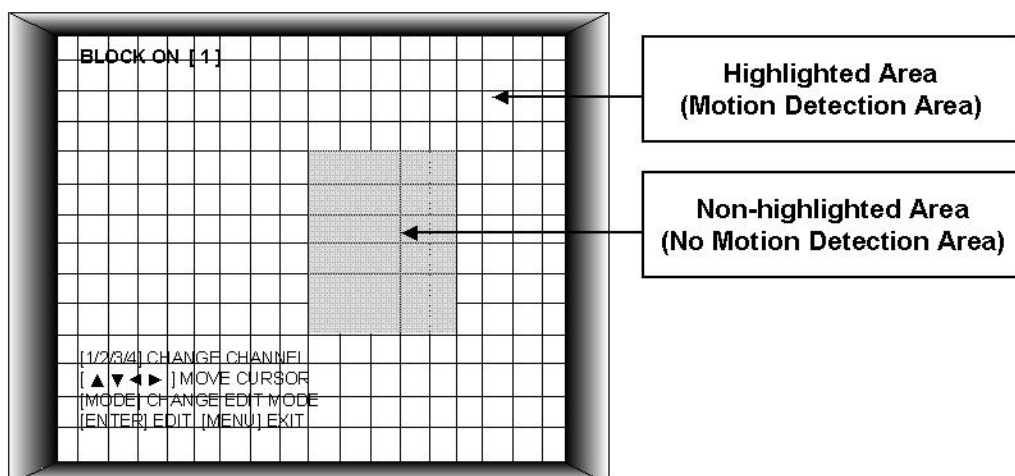

**4) INTERVAL SETUP**

Set the switching time interval for SEQ or PIP function.(1 sec. ~ 99 sec.)

(1)FULL SCREEN : set the sequencing switch time interval in live full screen.

(2)PIP SCREEN : set the sequencing switch time interval of PIP window.

(3)EVENT UPDATE TIME : Set the minimum time interval of event to be listed in EVENT LIST.  
If EVENT UPDATE TIME is set at 20 sec, only following event happened 20 sec or more than 20 sec later previous event shall be listed in EVENT LIST.

INTERVAL SETUP	
SWICHING INTERVAL	
FULL SCREEN	01 SEC
PIP SCREEN	01 SEC
EVENT RECORD	
EVENT UPDATE TIME	600 SEC
SELECT ▲▼◀▶, CHANGE VALUE : - +	

**5) ALARM SETUP**

Set type of alarm sensors connected to DVR unit. N.O represents Normal Open type and N.C Normal Close type.

(1) ALARM INPUT : Select type of alarm sensor connected to DVR unit (N.O or N.C). Use direction button and [-] [+] button to set. DISABLE represents not to use alarm sensor connected to DVR.

(2) DURATION : Set the duration of alarm when an alarm is activated. (0 sec. ~ 300 sec.)

ALARM SETUP	
CHANNEL	CH1
ALARM INPUT	N.O
DURATION	005
N.O .....	NORMAL OPEN
N.C .....	NORMAL CLOSE
___ .....	DISABLE
SELECT : ▲▼, CHANGE VALUE : - +	

**6) EVENT POPUP SETUP**

When event is activated, the full image will pop up as user set.

(1)CHANNEL : Choose a channel

(2)POPOP ON/OFF : Set a popup function at ON/OFF

(3)EVENT : Set event mode which 'popup' function is applied to.

\*A : ALARM event. M : MOTION event.

(4)DURATION : Set the duration how long the popup Image is shown.(0 sec. ~ 60 sec.)

※If more than 2 channels pop up at the same time, the first channel out of them will be shown. (For e.g. Ch1 and CH3 pop up at the same time, CH1 will be shown)

EVENT POPUP SETUP	
CHANNEL	CH01
POPOP ON / OFF	OFF
EVENT	--
DURATION	0 3
SELECT : ▲▼, CHANGE VALUE : - +	

### 7) BUZZER SETUP

Set parameters for buzzer (On or Off).  
Use direction button and [OK] button.

KEY BEEP : buzz when button is pressed.  
VIDEO LOSS : buzz when video signal is lost.  
ALARM ACTIVE : buzz when alarm is activated.  
MOTION DETECT : buzz when motion is detected.

User can set all buzzers at On/Off at once  
by set ALL at ON/OFF.

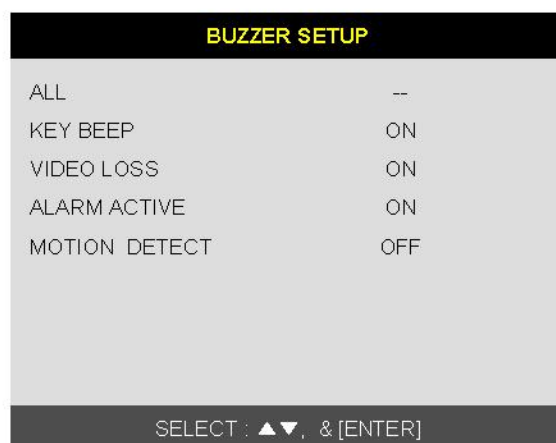

### 8) PASSWORD SETUP

Set user ID and password.

-Use [UP] and [DOWN] button to move to option  
and [LEFT] and [RIGHT] button to set user ID.

The password must be consist of 1 to 8 digit  
number. Just use numbers button from 1 to 10  
on the front panel of DVR unit.

-To change password, user must input current  
password and then input new password.  
And input again new password to confirm.

- Default value

ADMIN : ' ' (Blank)

MANAGER : '1'

USER 1 : '2'

⋮

USER 8 : '9'

※ Change the user PASSWORD in the first operation is recommended.

※ In case you forgot PASSWORD, contact dealer of DVR to get instruction to enter into menu to set new PASSWORD.

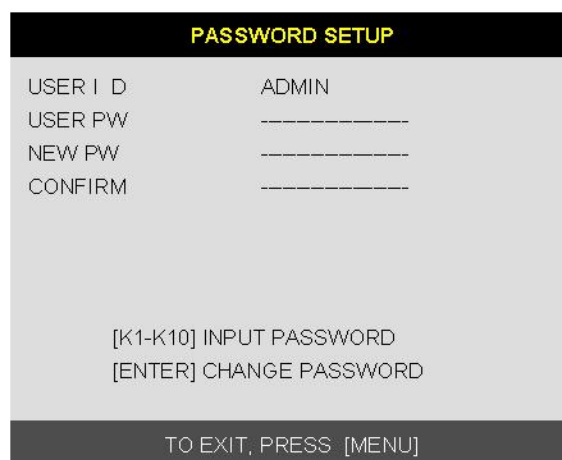

### 9) SYSTEM INFORMATION

DVR system information including firmware  
version, hardware version, product ID, etc....

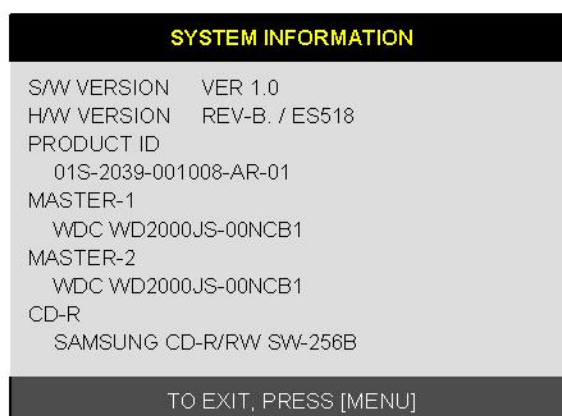

## 5-4. RECORD SETUP

This is the most important configuration of the DVR.  
Enter into SYSTEM MENU-RECORD SETUP  
and press the [OK] button.

### 1) RECORD CONFIGURATION

Use direction button to move and [-] [+] button to set value.

(1) OVERWRITE : Set overwrite or stop recording when the HDD is full.

(2) MULTIPLEX

- DUPLEX : Playback & Ethernet
- TRIPLEX : Playback & Recording & Ethernet

※ Note: DUPLEX MODE is recommended to playback the images at a maximum frame rate.  
But, it makes DVR not to record during search.

(3) QUALITY : Set recording picture quality.  
Actually it is fixing maximum data size of image for each picture quality in 5 steps as follows.

- BASIC
- NORMAL
- ENHANCED
- FINE
- SUPER FINE: Default quality set by manufacturer

In Emergency recording mode, recording quality is SUPER FINE.

To send more images via IP network and longer recording time, set QUALITY at NORMAL or ENHANCED and record at 360x240(360x288).

※ Data size of image in PAL system is a little bigger than NTSC system, but the total recording time is same as in NTSC system.

(4) RESOLUTION : Set recording resolution.  
- 120 ips at 720x240(NTSC) , 100 ips at 720x288(PAL)  
- 240 ips at 360x240(NTSC) , 200 ips at 360x288(PAL)  
- 480 ips at 360x120(NTSC) , 400 ips at 360x144(PAL)

※ Recording in Dual resolution is recommended for higher recoding speed, and also to send more images via IP network.

It is not possible to see those images in full screen mode in playback.

(5) RECORD IN ALARM : adjusts recording frame rate (IPS) in ALRAM record mode.

(6) RECORD IN MOTION : adjusts recording frame rate (IPS) in MOTION record mode.

(7) CONTINUOUS RECORD : adjusts recording frame rate (IPS) in CONTINUOUS record mode.

※ If you decrease frame rate, while you can have longer recording time, playback images may be choppy depending upon the frame rate that you decreased.



## 2) SCHEDULE SETUP

Unless you selected other recording mode, DVR system records in Schedule Recording mode. In SCHEDULE REC SETUP, you set type of recording for every time interval of 2 hours in each day of the week. Schedule Recording set by manufacturer is recording continuously at its full recording speed, and it means DVR system record continuously at 120 ips in total at 720x240 resolution. To set Schedule Recording parameters, enter into SYSTEM MENU-RECORD SETUP-SCHEDULE SETUP and Press the [ENTER] button.

### (1) SCHEDULE SETUP

Set recording type for each recording time interval for a day of the week (2 hours interval).

SCHEDULE REC SETUP							
	SUN	MON	TUE	WED	THU	FRI	SAT
00-02	-M-	AM-	--C	--C-	--C-	--C	--C
02-04	-M-	AM-	--C	--C	--C	--C	--C
04-06	-M-	AM-	--C	--C	--C	--C	--C
06-08	-M-	AM-	-C	-C	--C	-C	-C
08-10	---	AM-	--C-	--C	--C	--C	--C
10-12	--	AM-	--C	--C	--C	--C	-C
MODE: CELL BY CELL							1 / 2
▲▼◀▶ & [NEXT], EDIT:+ -&[MODE] A:ALARM M:MOTION C:CONTINUES							

Use [MODE] button to select edit type and move to the time interval of a day of the week you want to change. Press [OK] button to select and use [+] or [-] button, to change the record type. To go next page, use [NEXT] button.

- ※ MODE (Edit type)
- TIME CELL : Set each time interval of a day of the week
- WEEK : Set a day of the week at once
- TIME ZONE : Set a time slot at once
- ALL : Set page by page at once
- CLEAR ALL: Clear page by page

※ Unless user press [EMERG] button to record at full resolution and in SUPER FINE picture quality, DVR system records in SCHEDULE Record mode.

※ DEFAULT record mode for each time interval of a day of the week set by manufacturer is CONTINUOUS recording.

※ Record type :

- After power on ⇨ Schedule record
- Exit from menu ⇨ Schedule record
- End of search or playback ⇨ Schedule record
- After pressing [STOP] button ⇨ Schedule record
- After pressing [EMERG] button ⇨ Emergency record (Continuous recording in full performance) [120(100) ips at 720x240(720x288)]

## 3) HOLIDAY SETUP

Users can set national holiday or holidays on calendar to record just as setting for Sunday in SCHEDULE REC SETUP.

Use [MODE] button to select a month and direction button to move to a day, and press [OK] button to set a holiday. Then color of date shall be changed to red, as Sunday.

- EDIT HOLIDAY : Set as holiday
- CLEAR MON DATA : Cancel the holiday set per month
- CLEAR ALL DATA : Cancel all holiday set

※ The maximum holidays is 100 days.

HOLIDAY SETUP							
< APR >						001/100	
SUN	MON	TUE	WED	THU	FRI	SAT	
					01	02	
03	04	05	06	07	08	09	
10	11	12	13	14	15	16	
17	18	19	20	21	22	23	
24	25	26	27	28	29	30	
MODE : EDIT HOLIDAY SELECT ▲▼◀▶, EDIT [ENTER]&[MODE]							



## 5-5. BACK-UP

### 1) CD-R SETUP

User can back up the recorded data to CD using CD writer installed in DVR.  
Refer to [START] and [END] of data on HDD and set copy from time, [START], and size of data copied, [SIZE], and move to BURN and press [OK] button to start copy.

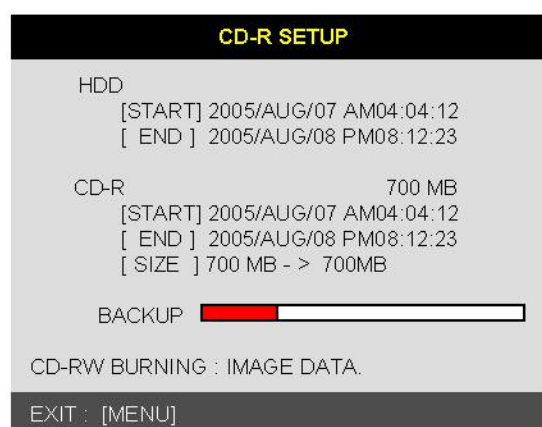
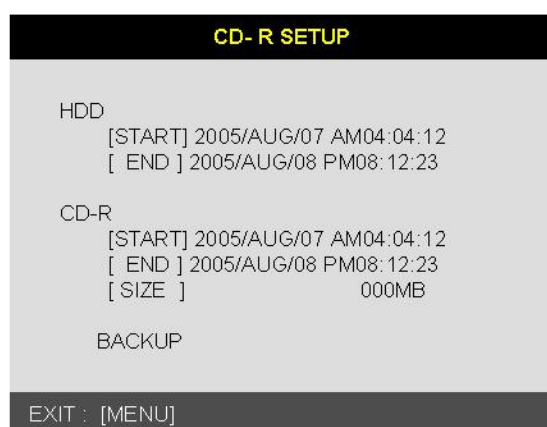

#### System Status Messages :

- CD-RW DOOR CLOSE. CHECKING CD Recorder : Blank CD check
- INPUT BLANK CD : CD Recorder has no blank CD.
- CD-RW DOOR OPEN : Open CD Recorder and insert blank CD Recorder media into CD drive.
- CD-R MEDIA IS DETECTED : Blank CD Recorder media has been inserted and detected.

DVR system will display size of blank CD Recorder .

After you set [START] time and [SIZE] in CD Recorder sub-menu and then select BURN, DVR system starts copying images to CD and shows following message.

CD-RW BURINING START  
 CD-RW BURNING : LEAD-IN  
 CD-RW BURNING : IMAGE DATA  
 CD-RW BURING : CLOSE TRACK  
 CD-RW DOOR OPEN

When burning is completed, CD Recorder media will be ejected automatically.

To copy more images, repeat above process. In the next back-up process, [START] time in CD Recorder sub-menu shall be [END] time in previous back-up, and you can copy images in series to many CDs as many as you want.

※ SIZE Change

+ , - : Change per 10MB unit

LEFT ; RIGHT : Change per 100MB unit

### 2) USB SETUP

User can back up the recorded data to USB Media using USB (HOST) port on front panel of DVR.  
Refer to [START] and [END] of data on HDD and set start and end time of data to USB Media ( USB Memory Stick ). Select backup file size, and move to BACKUP and press [OK] Button to start copy.

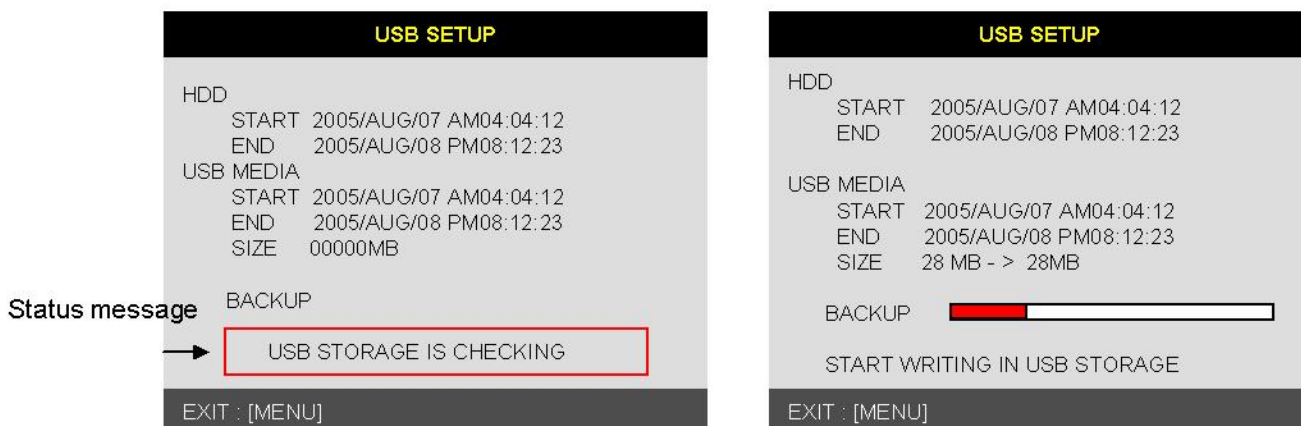

**System Status Messages**

- (1) If USB MEMORY STICK is not inserted :
  - USB STORAGE IS CHECKING
  - USB STORAGE IS NOT AVAILABLE
  - RE-CONNECT THE USB STORAGE
  - CONECT THE OTHER USB STORAGE
- (2) When USB MEMORY STICK is recognized
  - USB STORAGE IS CHECKING
  - THERE IS A FREE SPACE ON STORAGE
  - USB STORAGE IS AVAILABLE
- (3) During Back-Up
  - CHANGE WRITE PROTECT MODE (Only WRITE PROTECT is caught, it can be seen)
  - START WRITING IN USB STORAGE
  - FINISH WRITING IN USB STORAGE
- (4) Error Message
  - THERE IS A PROBLEM ON USB PORT (If USB PORT fails to work properly)
  - USB STORAGE IS FULL (When USB is full)
  - FILE SYSTEM IS NOT SUPPORTED (If File System is not supported)
  - SIZE IS LARGER THAN FREE SIZE (If back-up size is larger than free space)

- ※ Back-Up procedure is the same as CDR Back-Up.
- ※ If Back-Up size is larger than 2GB, it creates several files. (It saves by 2GB).

**5-6. EXTERNAL DEVICE**

Set parameters of external devices connected to DVR, like Ethernet, PTZ camera, RS-232C, etc. Use direction button to move to sub-menu and Press [OK] button to set.

**1) TCP/IP SETUP**

TCP/IP function enables user to see live pictures and recorded pictures via the internet.

**(1) IP CONFIG SETUP :**

Show the network information assigned to the DVR unit. If the DHCP setup status is AUTOMATIC, user can set the IP port only and if the DHCP setup status is MANUAL, user must set all parameters. For detail procedure of Remote viewer program installation, refer to CHAP. 6 Software program. (Remote viewer software).



(2) DDNS SETUP :

- DDNS ON/OFF : Select if DDNS Function use
  - DDNS SERVERS : IP Address of DDNS SERVER.
  - INTERVAL : Registered time period to DDNS SERVER.  
Per D (Day) H (Hour) M (Minute)
  - REGISTER : Once press [OK],  
IP address which is assigned from DHCP server is automatically input on DNS SERVER.
  - USER ID : Create "USER ID" without a space by using a mouse.  
(The first 3 digit number or characters must be input.)
  - DDNS STATUS : present current status by "REGISTER OK"  
"REGISTER ERROR", "NOT REGISTER"
  - IP ADDRESS : IP of last registered DVR
  - IP PORT : Port of last registered DVR
  - REMAIN TIME : Remain time to next registration
  - LAST REG... DATA : Last registered time
- (3) CONNECTION SETUP :

- TIME OUT :  
Adjust TIMEOUT value properly to successfully access to DVMR unit via Internet line. If data transmission speed is high enough, leave TIMEOUT value as set by manufacturer (200 msec), and increase it if data transmission via Internet line is relatively slow. Execute tracert (Tracing Route) in your PC for IP assigned to DVMR unit, and you can figure out how much TIMEOUT value increased.
- RETRY COUNT :  
Set the retry number of times for network connection.

(4) DHCP SETUP :

- DHCP MODE : If user selects AUTOMATIC, IP automatically assigned.  
  
If user selects MANUAL, in IP CONFIG SETUP User selects it manually.
- DETECT IP : It only appears for AUTOMATIC. Once press [OK], it automatically starts IP Assignment.

DDNS SETUP	
DDNS ON/OFF	OFF
DDNS SERVER	72.243.193.254
INTERVAL	D-00 H-00 M-20
REGISTER	
USER ID	[JM08001C]
-----	
DDNS STATUS	
IP ADDRESS	-----
IP PORT	----
REMAIN TIME	D-00 H-00 M-00
LAST REGISTRATION DATE	
>	
SELECT MENU : ▲▼, & [ENTER]	

CONNECTION SETUP	
TIMEOUT	200 MSEC
RETRY COUNT	08
SELECT MENU : ▲▼, & [ENTER]	

DHCP SETUP	
DHCP MODE	AUTOMATAIC
DNS SERVER	168.126.063.001
IP ADDRESS	192.168.001.086
SUBNET MASK	255.255.255.000
GATEWAY	192.168.001.001
SELECT : ▲▼, CHANGE VALUE : +-	

(5) EVENT SERVER SETUP :

IP ADDRESS : IP Address of PC that executes  
EVENT SERVER PROGRAM.

IP PORT : PORT of PC that executes  
EVENT SERVER PROGRAM

EVENT SERVER TYPE :

It is the way to transmit data to SERVER

By "OFF", "EVENT", "MINUTE",

In case Event happens from DVR.

"EVENT": It transmits by the number of EVENT.

"MINUTE": It transmits each scheduled time.

INTERVAL: If EVENT SERVER TYPE is "EVENT"

User can select from 1~512.

If EVENT SERVER TYPE is "MINUTE", User can select from 1 ~ 60 Min.

EVENT GMT TYPE : User can set currently installed location (DVR) of GMT.

EVENT SERVER SETUP	
IP ADDRESS	192.168.001.072
IP PORT	09988
EVENT SERVER TYPE	OFF
INTERVAL	---
EVENT GMT TYPE	GMT+00:00

SELECT : ▲▼, CHANGE VALUE : +-

(6) NVS SETUP :

BITRATE :

DATA SIZE from NVS. The bigger it set, the better its  
quality, but sometimes motion is not smooth.

(Set Value : 100K ~ 2500K, can be adjusted by 50K)

NVS SETUP	
BITRATE	0500 Kb
FRAMERATE	10

SELECT : ▲▼, CHANGE VALUE : +-

FRAMERATE :

DATA RATE from NVS. The bigger it set, the better its quality, but image quality is not good.

※ In order to work NVS properly, above value should be adjusted according to Network Condition.  
Please set Bit rate in accordance with upload speed of your DVR. For example, If the upload  
speed of DVR is 500Kbps, set Network speed 500Kbps.

## 2) RS-232C SETUP

User can control the DVR via RS-232C port.  
 Connect DVR to PC via RS-232C port and control DVR using keyboard of PC.  
 This function is mainly for programmer who wants to control DVR as part of many devices connected to PC system, as in SI project.

RS-232C SETUP	
SPEED	115200
LENGTH	8
STOP BIT	1
PARITY	NONE

SELECT : ▲▼, CHANGE VALUE : + -

## 3) PAN/TILT SETUP

It is to set parameters for PTZ camera connected to DVR unit. DVR unit already includes all protocols of well-known PTZ cameras like PELCO D type PTZ camera, and user just select MODEL and set other parameters to control this PTZ cameras, using operation buttons on the front panel of DVR.

PANTILT SETUP	
COMMAND SETTING	← PTZ camera set
SPEED SETTING	← PTZ speed set

SELECT : ▲▼, & [ENTER]

COMMAND SETTING	
CHANNEL	01
MODEL	PELCO-D
PTZ ID	000
BAUDRATE	2400 BPS
CMD DELAY	1 MSEC
COMMAND	PAN/TILT STOP
LENGTH	07
CODE	FF 00 00 00 00 00 00 00

SELECT : ▲▼, CHANGE VALUE : + -

- (1) CHANNEL : Select channel
- (2) MODEL : Select camera model (protocol type) per each channel
- (3) PTZ ID : Select ID
- (4) BAUDRATE : Select data transmission speed
- (5) CMD DELAY : Select command delay time

## 4) SPOT MONITOR SETUP

SPOT MONITOR SETUP	
SWITCH INTERVAL	03 SEC
ALARM POP UP	ON
MOTION POP UP	ON
EVENT POP UP DURATION	01 SEC

SELECT: ▲▼, CHANGE VALUE : + -

- (1) SWITCHING INTERVAL  
Channel switching time (01 sec. ~ 99 sec.)
- (2) ALARM POP-UP  
When ALARM is detected, the image of channel connected with Alarm sensor pops up.  
Set ALARM detection pop-up (ON/OFF)
- (3) MOTION POP-UP  
Set MOTION detection pop-up (ON/OFF)

※ EVENT POP-UP DURATION  
Set EVENT POP-UP DURATION

If events (MOTION or ALARM) happen on several channel at the same time, channel No. 1 has the first priority to pop up. For example, if events happen on channel No. 1, channel No. 2, and channel No. 4 at the same time, channel No. 1 pops up. If the motion disappears on channel No. 1, then channel No. 2 pops up for the duration that you set. However, even though motion happens on channel No. 1 again within the duration, channel No. 2 still displays. If motion on channel No.1 keeps on going even after the duration, channel No. 1 pops up again.

5) AUDIO SETUP

Use direction button to move to channel and Press [OK] button to set (ON/ OFF).

AUDIO SETUP		
CH	REC	PLAY
01	ON	ON
02	ON	ON
03	ON	ON
04	ON	ON

SELECT: ▲▼◀▶, & [ENTER]

1) REC

- (1) ON : Record images with AUDIO
- (2) OFF : Record images without AUDIO

2) PLAY

- (1) ON : Recorded sound comes out during playback
- (2) OFF : Recorded images only play back

6) AUDIO VOLUME SETUP

INPUT VOLUME: Adjust VOLUME of Recorded AUDIO

LIVE VOLUME1~4: Adjust VOLUME of LIVE per channel.

PLAY VOLUME1~4: Adjust VOLUME of PLAY per channel.

AUDIO VOLUME SETUP	
INPUT VOLUME	32
LIVE VOLUME1	32
LIVE VOLUME2	32
LIVE VOLUME3	32
LIVE VOLUME4	32
PLAY VOLUME1	32
PLAY VOLUME2	32
PLAY VOLUME3	32
PLAY VOLUME4	32

SELECT : ▲▼, CHANGE VALUE : + -

7) REMOCON SETUP

REMOCON TYPE: User use it to operate many DVRs installed at the same site and select each different TYPE.

N TYPE, S TYPE, U TYPE 1 ~ U TYPE 6: Total 8 TYPE Selectable.

REMOCON SETUP	
REMOCON TYPE	S TYPE

SELECT : ▲▼, CHANGE VALUE : + -

**5-7. FACTORY DEFAULT**

Set the all system parameters as manufacturer first set before delivery. It is a kind of system initialization, and manufacturer recommends to do it when you add new HDD or other changes in system to make all system ready for normal operation.

Use direction button to move and Press [OK] button to change parameters. After move to RUN, Press [OK] button for actual Factory Default setting.



**5-8. SYSTEM INFO SUMMARY**

Shows key information of system at one screen. (There are two different types.)

INFO TYPE 1 : displays S/W, H/W version, HDD information, network status

INFO TYPE 2 : displays Schedule setup, quality, resolution, recording frame rate, recording time etc.

\*By pressing [OK] button, INFO TYPE will be switching.

(A:ALARM RECORD, M:MOTION RECORD, C:CONTINUOUS RECORD)

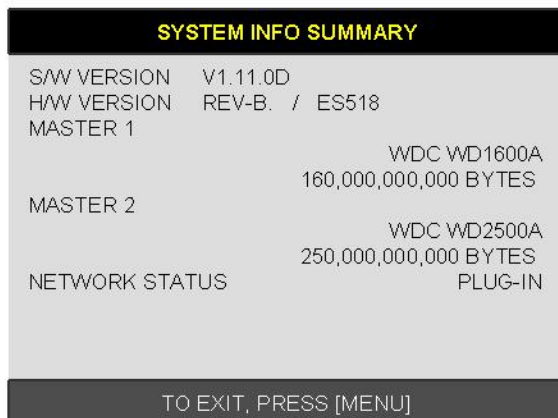

INFO TYPE 1

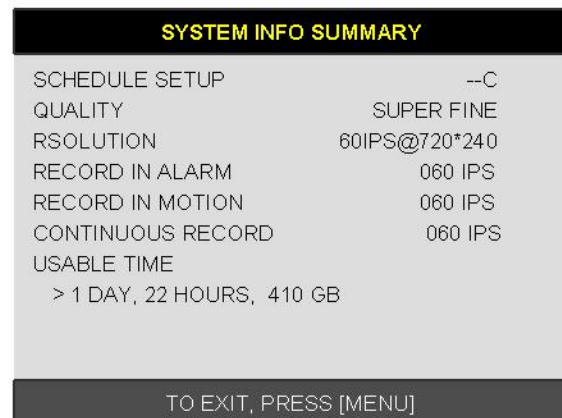

INFO TYPE 2

**5-9. LANGUAGE SETUP**

The menu can be displayed in a number of languages. Press [OK] button to select your language.



## CHAP. 6 Network Setup

### 6-1. DVR Network Configuration

Please call your provider to identify what type of service they are providing you.  
You will need to know following ;

Upload speed – For your own knowledge for expected frame rates

Download speed – For your own knowledge for expected frame rates

Addressing – For determining what scenario you should follow

Router On Site or Just a Modem – For determining what scenario you should follow

※NOTE : If your provider is using PPPOE (usually DSL providers), you MUST have a IP Share installed on site and follow **3) Dynamic IP of PPPOE (DSL)** for DVR setup and access.

※PLEASE verify Internet access after installing any new equipment (routers, switches, modems, etc.).

### PC's TCP/IP Setting

Before configuring the DVR, please fill out the information below if applicable ;

Choose any PC on your network and determine its TCP/IP settings;

IP Address : \_\_\_\_\_ (ex.192.168.1.5)

Subnet Mask : \_\_\_\_\_ (ex. 255.255.255.0)

Default Gateway : \_\_\_\_\_ (ex.192.168.1.1)

**Next pages are several network scenarios.** Please identify which scenario your current network falls within and follow the instructions for configuring and accessing your DVR via TCP/IP.



**1) Static IP**

**User input IP address in IP CONFIG SETUP which is assigned from ISP company.**

1. Verify if IP address is OK or not with PC before connecting DVR.
2. Connect LAN cable to DVR after confirmation.
3. DVR : MENU → EXTERNAL DEVICE → TCP/IP
4. Set DHCP to MANUAL and go into TCP/IP SETUP.
5. Verify if MAC ADDRESS starts from 00-0A-A2....
6. Input IP address which is assigned from ISP company.
7. Set IP PORT. (50000 recommended)
8. Input GATEWAY which is assigned from ISP company.
9. Input SUBNET MASK which is assigned from ISP company.
10. Go out of MENU SETUP.
11. Turn off and on Modem (Router) which is provided by ISP company.  
→ This is to reset client of MAC from ISP company.  
User have to wait for 30 seconds after turning on.
12. Access DVR with Remote Viewer software.

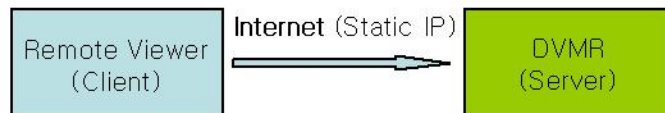

\* If user fail to access, please verify 1, 6, 7, 8, 9, 11 again.

\* When speed is too slow and connection fails after access : MENU → EXTERNAL DEVICE → TCP/IP SETUP → CONNECTION SETUP  
Increase value of Timeout to find the most suitable speed.

## 2) Dynamic IP

1. Verify if IP address is OK or not with PC before connecting DVR.
2. Connect LAN cable to DVR after confirmation.
3. Turn off and on Modem (Router) which is provided by ISP company.  
→ This is to reset client of MAC from ISP company.  
User have to wait for 30 seconds after turning on.
4. Turn off and on DVR.
5. DVR : MENU → EXTERNAL DEVICE → TCP/IP
6. Verify if MAC ADDRESS starts from 00-0A-A2....
7. Set DHCP to AUTOMATIC and detect IP to get Dynamic IP.
8. Go out of MENU SETUP after getting IP successfully.
9. Access DVR with Remote Viewer software.

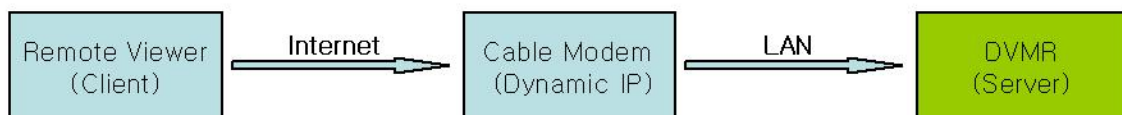

\* If user fail to access, please verify 1, 3, 4 again.

\* When speed is too slow and connection fails after access : MENU → EXTERNAL DEVICE → TCP/IP SETUP → CONNECTION SETUP  
Increase value of Timeout to find the most suitable speed.

**3) Dynamic IP of PPPoE (DSL)**

**DVR doesn't support DSL (PPPoE), user have to set NETWORK with IP SHARE if user need to access DVR remotely. At this time, User have to port forward on DVR. Please contact IP SHARE Manufacturer if you need to know how to forward port.**

**Even though user have Static/Dynamic IP, if user want to use another device (PC) through IP SHARE, user can set NETWORK as follows,**

1. Verify if IP address is OK or not with PC before connecting DVR.
2. Connect Router (IP SHARE) to DSL modem as shown the following picture.
3. Set the internet connection on Router (IP SHARE). (Refer to the Router Manual.)
4. Verify if sub-group of network in Router is OK or not.
5. Connect DVR to Router.
6. DVR : MENU → EXTERNAL DEVICE → TCP/IP
7. Set DHCP to MANUAL and go into TCP/IP SETUP.
8. Verify if MAC ADDRESS starts from 00-0A-A2....
9. Input internal IP address which user assigned from Router.
10. Set IP PORT. (50000 recommended)
11. Input GATEWAY of Router.
12. Input SUBNET MASK of Router.
13. Go out of MENU SETUP.
14. Forward port from Router. (Refer to the Router Manual.)
15. Access DVR with external IP and Port (Port forwarded).

\* If Router support DDNS, user can access Remote Viewer using Domain Information.



\* If user fail to access, please verify 1, 4, 15 again.

\* When speed is too slow and connection fails after access : MENU → EXTERNAL DEVICE → TCP/IP SETUP → CONNECTION SETUP  
 Increase value of Timeout to find the most suitable speed.

CHAP 7. DW Remote Center

MAIN INTERFACE



↑  
Exit

- |                      |  |
|----------------------|--|
| <b>NETWORK SETUP</b> | Inputs Information for DW Remote Center network connection.                    |
| <b>DVR CONFIG</b>    | Changes DVR setting over a network.  |
| <b>LIVE</b>          | Enables to show live image display.  |
| <b>TURBO LIVE</b>    | Enables to control DVR using virtual key like controlling actual DVR remotely. |
| <b>BACKUP</b>        | Enables to back up recorded images in DVR to your PC.                          |
| <b>BACKUP VIEWER</b> | Enables to back up recorded images on your PC. (AJP file)                      |

※ **System Requirement**

For the full performance of IRS program...

- 1) Dual Core CPU or Pentium IV 3.0 GHz (Hyper Threading supportable)
- 2) Memory : 1.0 GB

7-1. NETWORK SETUP

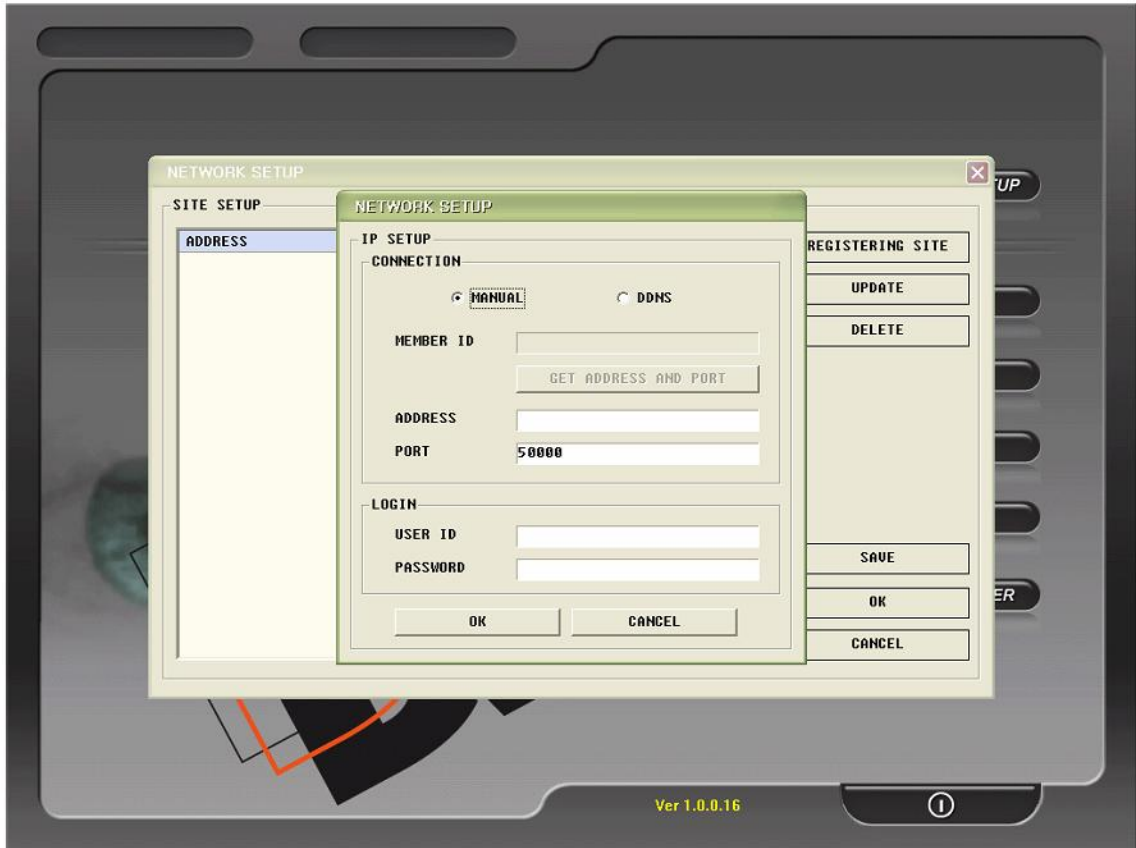

- MANUAL**            Select "Manual" to input IP address and port number manually.
- DDNS**             Select "DDNS" to use IP address and port number that you already registered in DDNS Server.
  
- MEMBER ID**        Input member ID that you registered in DDNS Server.
- NAME**              Input DVR name that you registered in DDNS Server.
  
- ADDRESS**         Input IP address manually.
- PORT**              Input Port number manually.
  
- LOGIN**
- ID**                  Input DVR ID which has been set in DVR already. (Input 'admin'.)
- Password**         Input password of DVR.

7-2. DVR CONFIG



User can change some settings of DVR listed below over a network.  
 (Active Camera, Alarm, Buzzer, Interval, Password, Record Configuration, Record Schedule)

**MANUAL** Input IP address and port number of DVR manually.

**ADDRESS** Input IP address of DVR manually.  
**PORT NUMBER** Input port number of DVR manually.

**LOGIN**  
**ID** Input DVR ID which has been set in DVR already. (Input 'admin'.)  
**PASSWORD** Input password of DVR.

**CLOSE** Click "CLOSE" to exit.

7-3. LIVE

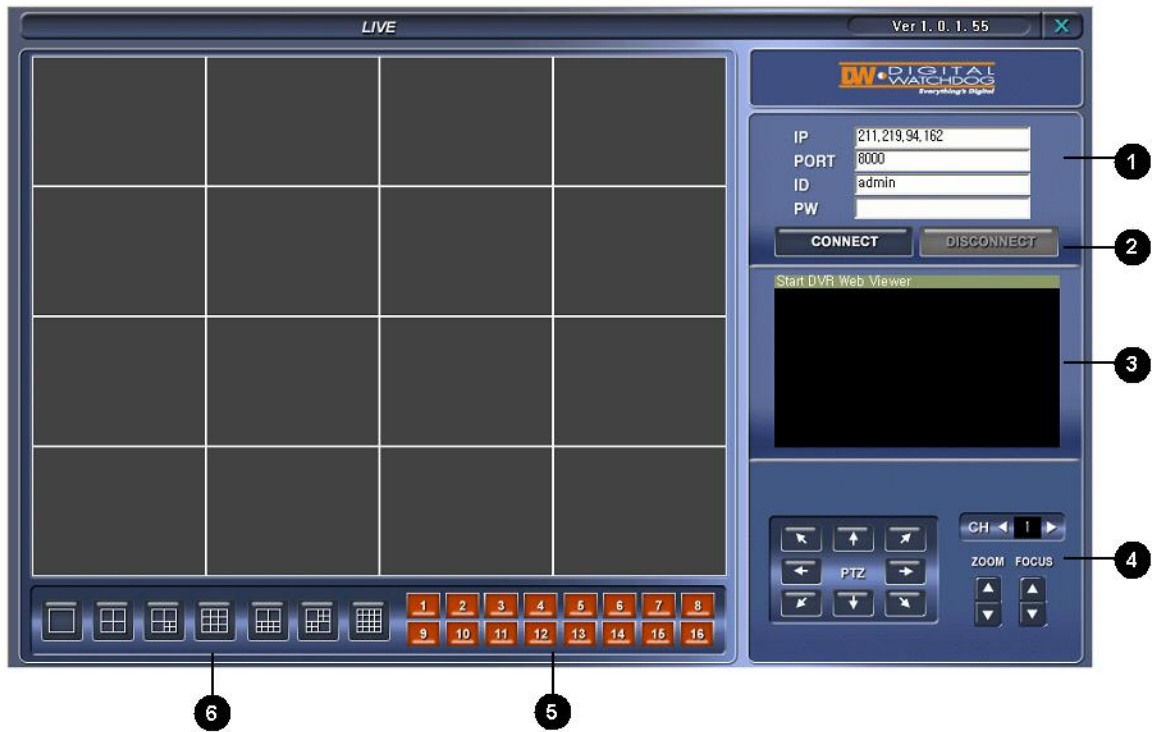

- ① **DVR connection setup** : Input network information to connect.  
(IP / PORT / ID / PW)
- ② **Network Connection**
  - a) **CONNECT** : Click this button to connect to DVR & see live view over a network.
  - b) **DISCONNECT** : Click this button to disconnect.
- ③ **System Information** : Displays connection status and operating Information.
- ④ **PTZ Control** : Command PTZ Camera connected to DVR remotely.  
( To command PTZ remotely, User must complete PTZ setting in DVR)
- ⑤ **Channel button** : Selects channel that displays in full screen.
- ⑥ **Screen division** : User can select screen division.

7-4. TURBO LIVE



- ❶ **DVR Connection Setting** : Inputs information for DVR Network connection .  
Check 'IP / PORT / ID / PW' information.
- ❷ **Network Connection**
  - a) **CONNECT** : Network connection to DVR. ( User can see live image of DVR. )
  - b) **DISCONNECT** : Network disconnection from DVR.
  - c) **SETUP** : User can change or set 'NVS Setup' of DVR System Menu.
- ❸ **System Information** : Displays DVR Connection and System Operation Information.
- ❹ **PTZ Control** : User can control PTZ camera connected to DVR remotely.  
( To control PTZ remotely, user must set PTZ setting in DVR in advance.)
- ❺ **DVR Virtual Key** : To use Virtual Key that works the same function as DVR to control DVR remotely.

a) Bit rate: shows received data from network. Please refer to "set up" in Network Connection.  
b) AUDIO: it currently does not support. It will be supported soon.



SETUP (NVS Setup)

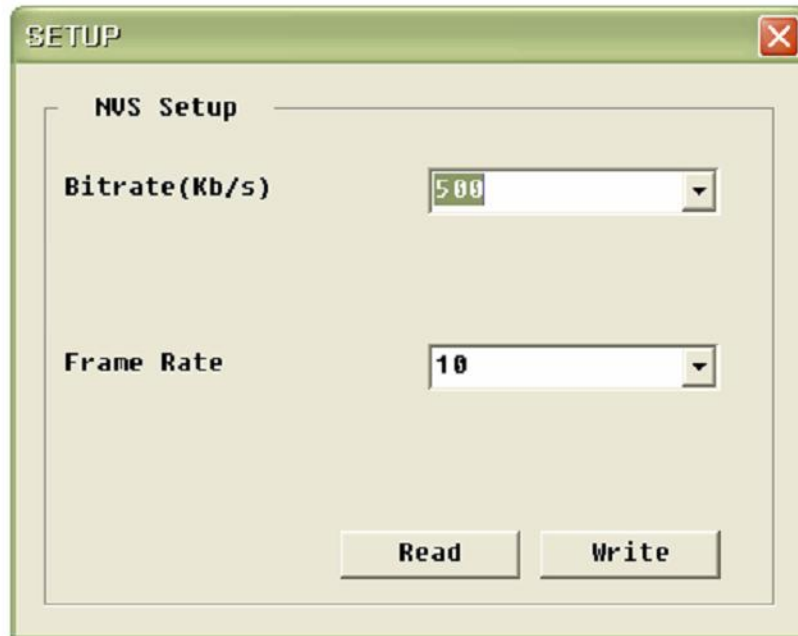

**Bitrate(Kb/s)**

DATA SIZE from NVS. The bigger it set, the better its quality. But sometimes image is not smooth. (Set Value : 100Kb ~ 2500Kb, can be adjusted by 50K)

※ Please set Bitate in accordance with upload speed of your DVR. For example, If the upload speed of DVR is 500Kbps, set Bitrate 500Kbps.

**Frame Rate**

DATA RATE from NVS. The bigger it set, the better its movement. But sometimes image is not smooth.

**Resolution**

DATA RESOLUTION from NVS. Such as 160\*120, 320\*240, 640\*240, 640\*480.

\* In order to work NVS properly, above value should be adjusted according to Network Condition.

7-5. BACKUP

1) To execute BACKUP, input IP Address & Port and click 'Connect Test' button.



2) After Connect Test is done, you can see 'Success Connect Test!' message. Then, click 'lock' button and click 'Set Backup Time' button.

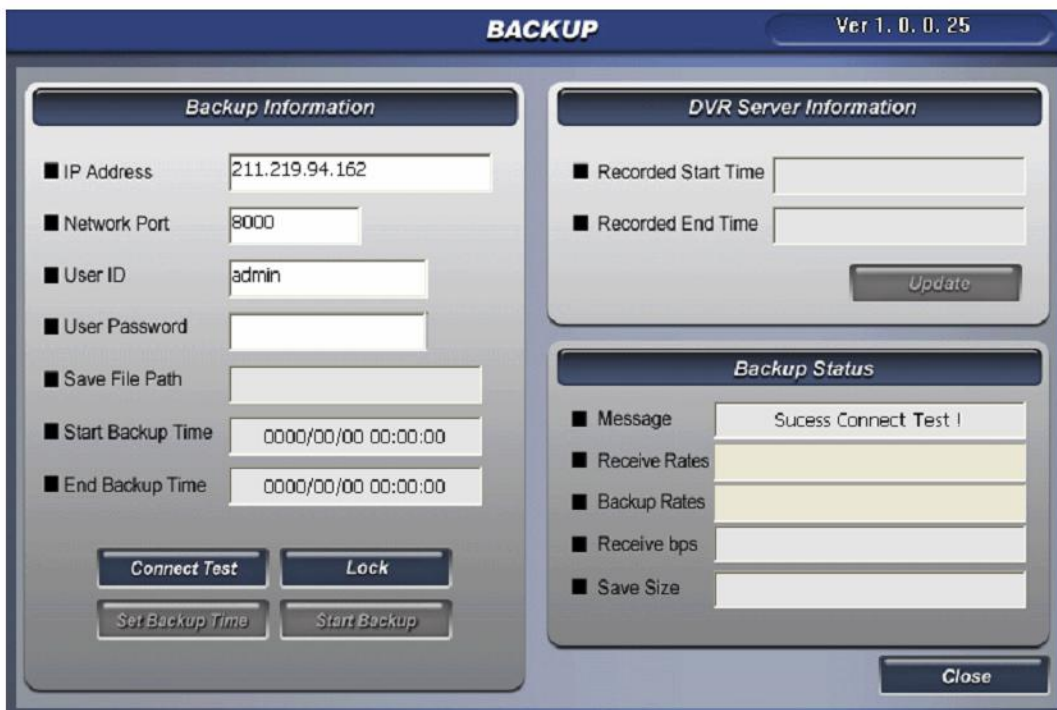

3) Now you set 'Start Time', 'End Time', 'Save File Path', 'File Size' and click 'Apply'.



4) After finishing time setting, click 'Start Backup' to start backup. Then, you can see the backup on the path that you chose.



7-6. BACKUP VIEWER



- 1 Time Display : Displays current time.
- 2 Recorded data display : Displays start time & end time of recorded data.  
Also, displays operating status during playback.
- 3 Screen display : Selects full screen mode or split mode and displays full screen for each ch.
- 4 Audio : Set Audio On/Off.
- 5 Function buttons
  - a) OPEN : Selects backup file.( AJP File )
  - b) EDIT : Enables to edit backup image, then save and print.
  - d) AVI SAVE : Save backup images in AVI file format.
  - c) EXIT : Ends backup player.
- 6 Operation buttons : Search for recorded data.
  - a) Go to the beginning of recorded data and play.
  - b) Fast backward playback.
  - c) Backward playback.
  - d) Pause.
  - e) Forward playback.
  - f) Fast forward playback.
  - g) Go to the end of recorded data and play.
- 7 Playback speed setting button : Able to adjust playback speed by using upper/ lower buttons.
  - a) SPEED : decides playback speed.(1/4X,1/2X,1X,2X,4X,8X,16X)
  - b) DELAY : adjusts playback interval. The higher, the slower.(1, 2, 4, 8, 16, 32)
- 8 Play bar : Enables to search recorded data by using this bar.

Image EDIT



**1** EDIT TOOL : User can adjust color tone of copied images using this buttons.

- Contrast

: make bright part of image brighter and dark part of image darker

: To reduce light and shade, lower contrast a little

- Brightness

: make an image brighter

: make an image darker

- Sharpness

: gives sharp-edge effect

- Blur

: make an image soft.

- Operation buttons

: saves data in JPEG file format.  
It is saved in the folder where player is installed.

: User can print current image selected.

**2** EDIT : Return to player mode.

AVI SAVE



- 1** **OPTION** : Used to save data in AVI file format.

  - CHANNEL : Selects channel.
  - FRAMERATE : Decides frames per second of data to be saved.
  - SIZE : Decides the size of data to be saved automatically.
  - START : Starts saving.
  - STOP : Stops saving. Once stopped, 'C:\WEB\_BACKUP' folder is opened automatically.
  
- 2** **AVI SAVE** : Opens 'option' setting to start AVI saving. Closes 'option' setting after finishing AVI saving and go back to player mode.

CHAP. 8 Simple DDNS

\* The following setting is a sample for a cable modem connected to DVR directly.

- 1) Click Menu and Enter into 'LOGIN -> EXTERNAL DEVICE -> TCP/IP SETUP'
- 2) Go to IP Config Setup, if user set DHCP 'Automatic', it detects IP address automatically.

<b>IP CONFIG SETUP</b>	
MAC ADDRESS	----- 00-0A-A2-00-00-00
IP ADDRESS	----- 192.168.001.160
IP PORT	----- 50000
GATEWAY	----- 192.168.001.001
SUBNET MASK	----- 255.255.255.000
DHCP SETUP	AUTOMATIC
<b>SELECT MENU : ▲ ▼ , &amp; [ENTER]</b>	

- 3) Go to the previous menu and enter into DDNS Setup.

<b>TCP/IP SETUP</b>
IP CONFIG SETUP
DDNS SETUP
CONNECTION SETUP
DHCP SETUP
EVENT SERVER SETUP
NVS SETUP

4) Set DDNS ON/OFF "ON".

IP address which is assigned from DHCP Server is automatically input on DNS Server.

Create "USER ID" without a space by using a mouse. (The first 3 digit number or characters must be input.)

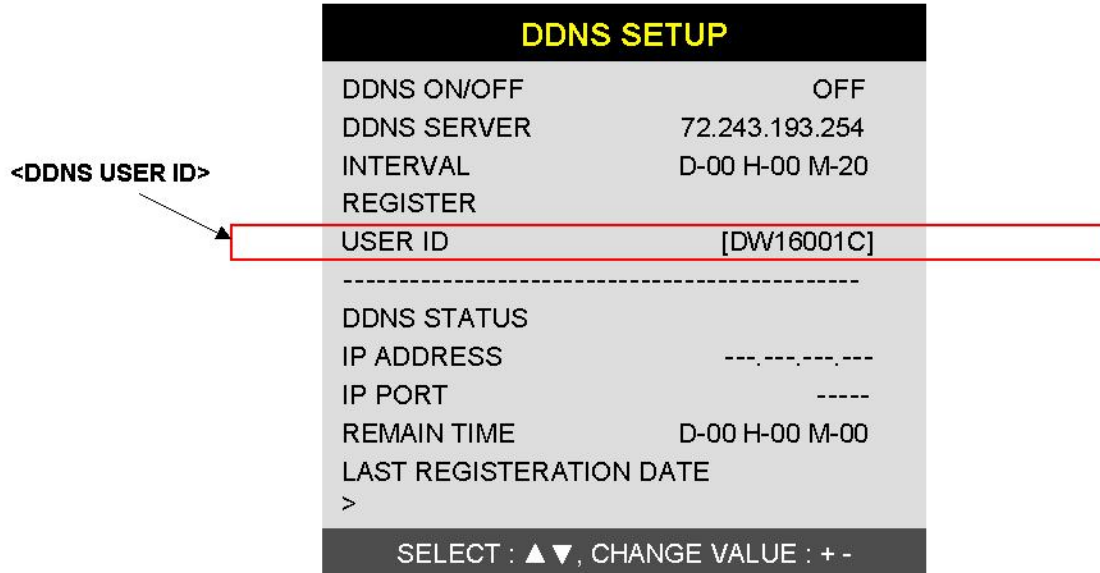

5) Go down to REGISTER and push ENTER button to renew IP and Port registered on DDNS Sever.

( Interval : connection interval time between DVR and DDNS Server)

D = Day, H = Hour, M = Minute

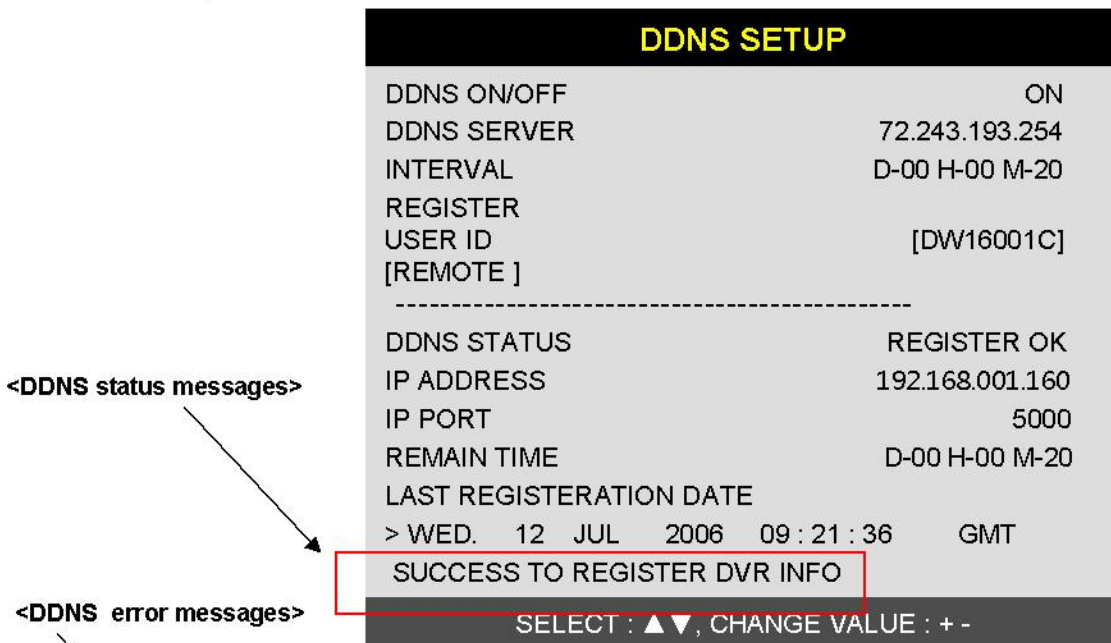

**FAIL TO COMMUNICATE WITH DDNS SERVER :**  
 (In this case, check out whether DNS server IP address is 72.243.193.254. If the IP address is same, please try another DNS server IP address provided by your ISP.)

**FAIL TO REGISTER DVR INFO :**  
 (In this case, please check out whether you registered your DVR in <http://za.dwdns.com>. And also check out your MAC address in your DVR is same as the one that has been registered in <http://za.dwdns.com>.)



6) To use simple DDNS service, open web browser and type in [http://za.dwddns.com/User\\_ID](http://za.dwddns.com/User_ID). <USER ID> should be created before using DDNS service. For example, if user ID is "remote", you need to type <http://za.dwddns.com/remote> in web browser.



※ If you are using a router, you need to do "port forwarding" or "DMZ setting".

7) If User ID is correct one, you will see the interface as shown below.



For more detail operational guide, please refer to 'Chap 7. DW Remote Center'.

DVR CONFIG	Changes DVR setting over a network.
LIVE	Enables to show live image display.
TURBO LIVE	Enables to control DVR using a virtual key like controlling actual DVR remotely.
BACKUP	Enables to back up recorded images in DVR to your PC.
BACKUP VIEWER	Enables to back up recorded images on your PC. (AJP file)

CHAP.9 Programmer reference

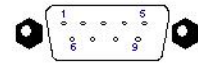

RS-232C

1) Connector Pin Assignment

No		Description	NO		Description
1	DCD	Data Carrier Detect	6	DSR	Data Set Ready
2	RxD	Receive data	7	RTS	RS232C: Rx/Tx data
3	TxD	Transmit data	8	CTS	RS232C: Rx/Tx data
4	DTR	Data Terminal data	9		
5	GND	Signal Ground			

2) RS232 ASCII-CODE

We qualify that the ASCII information is provided only as reference material for programmers to aid them in using these RS-232 ASCII primitive commands for integration into user developed software and applications

(The following table is based on 16ch DVR.)

All ASCII-Code is 1 Byte.

REC	'R'	DOWN	'J'	PTZ	'T'	KLOCK	'C'	CH5	'5'	CH12	'@'
STOP	'S'	LEFT	'H'	ZOOM	'Z'	ULOCK	'O'	CH6	'6'	CH13	'#'
PLAY	'P'	RIGHT	'K'	FRZ	'F'	QPLAY	'Y'	CH7	'7'	CH14	'\$'
Pause	'A'	NEXT	'N'	MODE	'D'	CH1	'1'	CH8	'8'	CH15	'%'
SERCH	'E'	ENTER	0x0d	PIP	'I'	CH2	'2'	CH9	'9'	CH16	'^'
MENU	'M'	-	'<'	SEQ	'Q'	CH3	'3'	CH10	'0'		
UP	'U'	+	'>'	J.SHU	'L'	CH4	'4'	CH11	'!		

Jog / Shuttle

Please input 'L' command to activate J/SHUTTLE function using keyboard of PC.

Shuttle 0 degree	"&>0"[enter]	Shuttle Left 10 degree	"&<1"[enter]
Shuttle Right 10 degree	"&>1"[enter]	Shuttle Left 20 degree	"&<2"[enter]
Shuttle Right 20 degree	"&>2"[enter]	Shuttle Left 30 degree	"&<3"[enter]
Shuttle Right 30 degree	"&>3"[enter]	Shuttle Left 40 degree	"&<4"[enter]
Shuttle Right 40 degree	"&>4"[enter]	Shuttle Left 50 degree	"&<5"[enter]
Shuttle Right 50 degree	"&>5"[enter]	Shuttle Left 60 degree	"&<6"[enter]
Shuttle Right 60 degree	"&>6"[enter]	Shuttle Left 70 degree	"&<7"[enter]
Shuttle Right 70 degree	"&>7"[enter]	Shuttle Left 80 degree	"&<8"[enter]
Jog Minus	"&-"[enter]	Jog Plus	"&+ "[enter]

Shuttle : After inputting a command once, it will keep performing the command until next command.

Jog : It makes the stage staying after one time operation by command input like Button operation.

•Key Release for PTZ function

power on , light on	"1"
power off , light off	"2"
iris open	"3"
iris close	"4"
focus near	"5"
focus far	"6"
zoom in	"7"
zoom out	"8"
set preset	"9"
clear preset	"0"
goto preset	"!"
auto scan	"@"
tilt up	"u"
tilt down	"j"
pan left	"h"
pan right	"k"



"&Z"  
"Enter"

•To stop transmitting the signal to DVRs via RS232

1) Set preset

"T" → "U", "J", "H", "K" (To move where you want to see) → "9"( set preset ) → "&Z" "Enter"  
→ "&+" "Enter", "&- "Enter" (To set other preset point)

2) Clear preset

"T" → "0" → "&Z" "Enter" → "&+", "&- (To choose which you want to delete ) → "Enter"

3) Goto preset

"T" → "!" → "&Z" "Enter" → "&+", "&- ( To choose where you want to see ) → "Enter"

※ Reference

1. Functions where the OSD [xx] to the right of the function is not seen pressing "1" or "2" will bring it up.

2. Operations such as 'clear preset' take effect upon pressing the '0' key causing the last preset to be deleted even though that may not be the desired action. Instead use the next key 'N' until 'clear preset' is up then choose the preset to be deleted followed by enter.

3. For units lacking a front panel jog shuttle the '15/F3' and '16/F4' ASCII front panel equivalent can be used.

**CHAP. 10 Specifications**

- Dual Codec : JPEG2000 recording & H.264 image transferring
- Simple DDNS
- Real time live display in all channels
- 16 channel video 480(400)ips recording capability
- Triplex (Playback/Recording/Ethernet)
- Multi-language menu
- Remote monitoring and download through network
- Convenient search function with Jog/shuttle
- VGA option available (Supporting TFT LCD Monitor)
- USB (Device) port for firmware upgrade
- Easy PTZ camera control by pre-assigned buttons
- Password Protection
- User-Friendly Environment by MOUSE

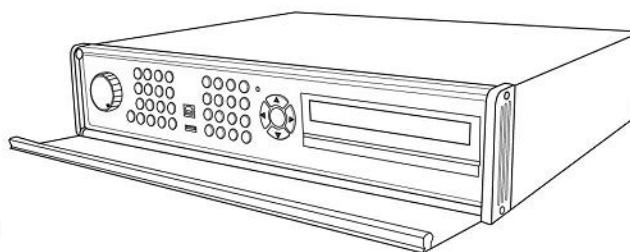

Multiplex function			Triplex (Playback/Recording/Ethernet)
Storage	Internal	HDD	Up to 2 HDDs with no limitation in capacity
Capacity		CD Recorder	For Backup
Video	Inputs	Composite	16Ch
		Outputs	Composite 2Ch (Monitor / SPOT)
		VGA	1Ch (Supporting TFT LCD Monitor/Option)
		Loop out	16Ch
	Compression		JPEG-2000(Record), H.264(Network)
Compression Rate (Image size fixed)			Basic
			Normal
			Enhanced
			Fine
			Super Fine
	Display Speed		Real Time display
Recording	Recording Mode		Schedule (Time, Motion, Alarm), Emergency
/Search	Search		Event Search, Date/Time Search, Search Bar (Jog/Shuttle)
	Recording Speed (NTSC/PAL)		Full (120/100), Dual (240/200)
	Recording Resolution (NTSC/PAL)		Full (720x240/720x288), Dual (360x240/360x288)
Multi-language			English, Spanish, German, Italy, France, to be added more
Switching Interval			1~99 sec selectable
Live Division Screen			1 / 4/ 6/ 8/ 9/ 13/ 16 Split
			Digital Zoom, Freeze function available in Live mode, PIP, SEQ
Alarm	Inputs		16 Alarms (NO/NC selectable in SETUP menu)
	Outputs		1 (NO/NC)
	Post Alarm		Duration of alarm output : 1 sec ~ 300 sec selectable
Motion Detection			Area division : 16 x12 / Detection Division : 32 x 24
Network			Ethernet (TCP/IP), Remote viewer program included
Backup			VCR, CD Recorder back-up, USB backup, Download via IP Network
PTZ Control			RS-485, Key Control( Key assigned for each PTZ command)
Firmware upgrade			USB port for firmware upgrade, CD Recorder
Serial I/F		RS-485	For PTZ camera control
		RS-232C	For operation using keyboard of PC
AUDIO	Input		4CH Microphone Input
	Output		1CH Speaker Output
Power Requirements			DC 12V 6.67A Adaptor
Weight			8.5kg
Dimensions (WXHXD) mm			436 X 396 X 88
Packing			600 X 520 X 180

Design and specifications are subjected to changes without notice

## Warranty Information

**Digital Watchdog** (referred to as "the Warrantor") warrants the Digital Video Recorder against defects in materials or workmanship as follows:

**LABOR:** For the initial two (2) years from the date of original purchase, if the Digital Video Recorder is determined to be defective, the Warrantor will repair or replace the unit, with new or refurbished product at its option, at no charge. Labor will not be covered by the Warranty the subsequent three (3) years.

**PARTS:** In addition, the Warrantor will supply replacement parts for the initial two (2) years. The subsequent three (3) years of the Warranty will only cover the Hard Drives.

To obtain warranty or out of warranty service, please contact a Technical Support Representative at 1-866-446-3595 Ext 242 Monday through Friday from 9:00 AM to 5:00 PM Eastern.

A purchase receipt or other proof of the date of the original purchase is required before warranty service is rendered. This warranty only covers failures due to defects in materials and workmanship which arise during normal use. This warranty does not cover damage which occurs in shipment or failures which are caused by products not supplied by the Warrantor or failures which result from accident, misuse, abuse, neglect, mishandling, misapplication, alteration, modification, faulty installation, set-up adjustments, improper antenna, inadequate signal pickup, maladjustment of consumer controls, improper operation, power line surge, improper voltage supply, lightning damage, rental use of the product or service by anyone other than a Digital Video Recorder authorized repair facility or damage that is attributable to acts of God.

### LIMITS AND EXCLUSIONS

There are no express warranties except as listed above. The Warrantor will not be liable for incidental or consequential damages (including, without limitation, damage to recording media) resulting from the use of these products, or arising out of any breach of the warranty. All express and implied warranties, including the warranties of merchantability and fitness for particular purpose, are limited to the applicable warranty period set forth above.

Some states do not allow the exclusion or limitation of incidental or consequential damages, or limitations on how long an implied warranty lasts, so the above exclusions or limitations may not apply to you. This warranty gives you specific legal rights and you may also have other rights that vary from state to state.

If the problem is not handled to your satisfaction, then write to the Address above.

Service calls which do not involve defective materials or workmanship as determined by the Warrantor, in its sole discretion, are not covered. Costs of such service calls are the responsibility of the purchaser.

MEMO :

MEMO :

MEMO :





DW – ZA Pro