

DW-916 Manual

- This manual is published by Kaltech and contains information on DW-916 which will enable you to use this product properly.
- If you require additional copies of this manual, please print the manual contained in the CD provided with your purchase.



Introduction

Thank you for purchasing Kaltech DW-916 .

This DVR is produced by the most advanced Kaltech technology and its quality is guaranteed by strict reliability and compatibility testing.

This DW-916 manual provides necessary information for the correct use of this product and also contains some useful tips.

Please read this manual thoroughly before using DW-916 in order to prevent possible breakdown due to any mishandling.

Notice

User's guide for DW-916 DVR.

This manual applies to DW-916 DVR only.

This manual describes external features of the DW-916 DVR, part names, correct connection methods for supported domes or Pan/Tilt receivers, control devices, peripheral devices, and the system set up instructions. It should be noted that some features, figures, pictures and references can only be applied to one model either DW-916.

- Kaltech can not be held responsible if the DVR is damaged due to non-compatible devices being used with this product. If you have any doubts please check.
- Kaltech can not be held responsible if the DVR is damaged due to the product being disassembled or modified by the user.
- If you wish to open the system casing to attempt to modify, repair, or upgrade the system, it is recommended that you ask for a Kaltech engineer's assistance by contacting either your dealer or Kaltech head office.
- Digital Watch dog and DW-916 are registered trademarks of Kaltech
- This product is qualified for both domestic and industrial use. This product is qualified under the Radio Equipment Requirements of Korea and acquired international certification including CE (Europe) and FCC (USA).

Manual Edition 1.00.01.A – May 2006

©2003-2005, Kaltech Enterprises
All Rights reserved.

No part of this documentation may be reproduced in any means, electronic or mechanical, for any purpose, except as expressed in the Software License Agreement. Digital Watchdog shall not be liable for technical or editorial errors or omissions contained herein. The information in this document is subject to change without notice.

The information in this publication is provided "as is" without warranty of any kind. The entire risk arising out of the use of this information remains with recipient. In no event shall Digital Watchdog be liable for any direct, consequential, incidental, special, punitive, or other damages whatsoever (including without limitation, damages for loss of business profits, business interruption or loss of business information), even if Digital Watchdog has been advised of the possibility of such damages and whether in an action or contract or tort, including negligence.

This software and documentation are copyrighted. All other rights, including ownership of the software, are reserved to DIGITAL WATCHDOG INCORPORATED. DIGITAL WATCHDOG, Digital Watchdog, DW-Pro, and High Definition Digital Recorder are registered trademarks of Kaltech Enterprises Inc in the United States and elsewhere; Windows, and Windows 2000 are registered trademarks of Microsoft Corporation; DirectCD is a registered trademark of Roxio Corporation. All other brand and product names are trademarks or registered trademarks of the respective owners.

The following words and symbols mark special messages throughout this guide:



WARNING: Text set off in this manner indicates that failure to follow directions could result in bodily harm or loss of life.



CAUTION: Text set off in this manner indicates that failure to follow directions could result in damage to equipment or loss of information.

Kaltech Enterprises

5436 W Crenshaw St · Tampa, FL 33634 · U.S.A

Office 1-813-888-9555 · Fax 1-813-888-9262 · Tech Support 1-866-446-3595 Ext 242

Kaltech Enterprises

DIGITAL WATCHDOG END-USER SOFTWARE LICENSE AGREEMENT

Version 1.0, June 2001

IMPORTANT: Read this before using any commercial software available from Kaltech Enterprises

This document ("License") is a legal agreement between you (an individual or business) and Kaltech Enterprises Inc ("Kaltech Enterprises"). Use of the enclosed or downloaded software indicates your acceptance of these terms. As used in this License Agreement, the term "SOFTWARE" means the software included on the CD, via download or disk media provided with this License Agreement. The term "SOFTWARE" does not include any software that is covered by a separate license offered or granted by a person other than Kaltech Enterprises and this License does not grant any rights in such software.

Copyright laws and international copyright treaties, as well as other intellectual property laws and treaties protect the SOFTWARE. The SOFTWARE is licensed, not sold.

IF YOU DO NOT AGREE TO THESE TERMS AND CONDITIONS, EITHER DESTROY, OR RETURN INTACT, THE SOFTWARE PACKAGE, CONTAINING THE CD OR DISK MEDIA, TOGETHER WITH THE OTHER COMPONENTS OF THE PRODUCT TO THE PLACE OF PURCHASE FOR A REFUND OF THE PURCHASE PRICE.

1. PROPRIETARY RIGHTS. The SOFTWARE, HARDWARE and any associated documentation are proprietary products of Kaltech Enterprises or its licensors. And are protected under U.S. and European copyright, trademark, patent and trade secret laws and international treaty provisions. Sole ownership of the SOFTWARE, HARDWARE and all copies, modifications, translations, and merged portions thereof shall at all times remain with Kaltech Enterprises or its licensors.

2. GRANT OF LICENSE AND TERM. The SOFTWARE and accompanying documentation are being licensed to you. This means you have the right to use the SOFTWARE only in accordance with this license agreement. The SOFTWARE is considered in use on a computer when it is loaded into temporary memory or installed into permanent memory. This license may not be assigned or otherwise transferred without prior written consent from Kaltech Enterprises, and any unauthorized transfer makes the license null and void.

a. LICENSING

i. PERSONAL LICENSE AND COMPUTER-SPECIFIC LICENSE FOR THE SERVER SOFTWARE.

You the End User are authorized to use the server software on NO MORE THAN the number of DW-Pro computers for which you have purchased licenses. All copies of the SOFTWARE must include the Kaltech Enterprises copyright, confidentiality, trademark and patent notices. This License is personal to you. You may not sublicense, lease, sell or otherwise transfer the Software or any of the accompanying documentation to any other person. You may use the Software only for your own personal use if you are an individual or for your own internal business purposes if you are a business. Each permitted copy of the SOFTWARE may be used only in connection with a hard drive(s) that is (are)

the SOFTWARE may be used only in connection with a hard drive(s) that is (are) permanently connected to ONE specific DW-Pro computer (either a stand-alone computer or a computer connected to a network) owned or leased by you. If the SOFTWARE is made available on a network, only ONE specific DW-Pro computer may access it. Once the SOFTWARE has been accessed, by ONE specific computer, it may not be used on any additional computers without acquiring additional licenses from Kaltech Enterprises.

ii. PERSONAL LICENSE AND COMPUTER-SPECIFIC LICENSE FOR THE CLIENT SOFTWARE.

You the End User are authorized to use the client software on NO MORE THAN 30 computers. All copies of the SOFTWARE must include the Kaltech Enterprises copyright, confidentiality, trademark and patent notices. This License is personal to you. You may not sublicense, lease, sell or otherwise transfer the Software or any of the accompanying documentation to any other person. You may use the Software only for your own personal use if you are an individual or for your own internal business purposes if you are a business. Each permitted copy of the SOFTWARE may be used only in connection with a hard drive(s) that is (are) permanently connected to ONE specific DW-Pro computer (either a stand-alone computer or a computer connected to a network) owned or leased by you. If the SOFTWARE is made available on a network, only ONE specific DW-Pro computer may access it. Once the SOFTWARE has been accessed, by ONE specific computer, it may not be used on any additional computers without acquiring additional licenses from Kaltech Enterprises.

b. SERVER USE. To the extent that the applicable product invoicing or packaging sets forth, you may use the SOFTWARE on a Client Device or as a server ("Server") within a multi-user or networked environment ("Server Use") for either (i) connecting, directly or indirectly, to not more than the maximum number of specified Client Devices, or (ii) deploying not more than the maximum number of agents (pollers) specified for deployment. If the applicable product invoicing or packaging does not specify a maximum number of Client Devices, or pollers, this is a single product use license subject to subsection (a) above. A separate license is required for each Client Device or "seat" that may connect the SOFTWARE at any time, regardless of whether such licensed Client Devices or seats are connected to the SOFTWARE concurrently, or are actually using the SOFTWARE at any particular time. Your use of software or hardware that reduces the number of Client Devices or seats that connect to and use the SOFTWARE directly or simultaneously (e.g., "multiplexing" or "pooling" software or hardware) does not reduce the number of licenses required. Specifically, you must have that number of licenses that would equal the number of distinct inputs to the multiplexing or pooling software or hardware "front end"). If the number of Client Devices or seats that can connect to the SOFTWARE can exceed the number of licenses you have obtained, then you must have a reasonable mechanism in place to ensure that your use of the SOFTWARE does not exceed the use limits specified for the license you have obtained. This license authorizes you to make or download one copy of the Documentation for each Client Device or seat that is licensed, provided that each such copy contains all the proprietary notices for the Documentation.

c. **VOLUME USE.** If the SOFTWARE is licensed with volume use terms specified in the applicable product invoicing or packaging, you may make, use and install as many additional copies of the SOFTWARE on the number of Client Devices as the volume use terms authorize. You must have a reasonable mechanism in place to ensure that the number of Client Devices on which the SOFTWARE has been installed does not exceed the number of licenses you have obtained. This license authorizes you to make or download one copy of the Documentation for each additional copy authorized by the volume license, provided that each such copy contains all of the proprietary notices for the Documentation.

d. **STORAGE/NETWORK USE.** You may also store or install a copy of the SOFTWARE on a storage device, such as a network server, used only to install or run the SOFTWARE on your other computers over an internal network; however, you must acquire and dedicate a license for each separate computer on which the SOFTWARE is installed or run from the storage device. A license for the SOFTWARE may not be shared or used concurrently on different computers.

e. **TERM.** (i) This License is effective from the date of purchase of the License and shall remain in force until terminated. The End User may terminate this License at any time by destroying the SOFTWARE and its associated documentation, together with all copies of any form. (ii) Notwithstanding subparagraph d(i) above, this License may be terminated at any time by written notice of termination given by Kaltech Enterprises to the End User in any of the following circumstances: (A) If the End User shall expressly or impliedly repudiate this License by refusing or threatening to refuse to observe any of the conditions to which this License is subject; or (B) If the End User shall fail to make any payment due under and pursuant to this License or to observe any of the conditions to which this License is subject and, after the End User's attention has been drawn by notice to such failure, shall fail to remedy the matter to Kaltech Enterprises's reasonable satisfaction within thirty days of the giving of such notice;; or (C) If the End User shall have a receiver or administrative receiver or administrator appointed or shall enter into liquidation whether compulsory or voluntary or if the End User shall be unable to pay its debts as and when they fall due. (iii) On expiry, surrender, or other termination of this License, however such termination may arise, the End User shall cease to load, store, copy or use the Software and the associated documentation, shall delete the SOFTWARE from its computers and shall either surrender the SOFTWARE and the associated documentation, together with all copies in any form, to Kaltech Enterprises or shall destroy the same. The End User shall continue termination to observe and enforce confidentiality and secrecy in respect of the SOFTWARE and its associated documentation for the benefit of Kaltech Enterprises, and however termination may occur it shall not prejudice any right of action or remedy, which may have occurred prior to termination.

3. **BACKUP COPY.** In addition to any copies authorized for use under this License, the End User may make a single copy of the SOFTWARE solely for backup purposes.

4. **INTEGRITY OF THE SOFTWARE.** The End User shall not enhance or vary any part of the SOFTWARE nor procure or permit the whole or any part of the SOFTWARE (whether in its original or in any updated, enhanced, or varied form) to be incorporated into any other software or computer system. Translations, reverse programming, disassembling, and reverse engineering of the

SOFTWARE are expressly prohibited. Provided, however, that nothing in these conditions shall restrict (i) decompiling, notwithstanding that decompiling may involve adaptation, if the sole purpose of such decompiling is to achieve the interoperability of an independently created program with other programs, or (ii) any other act permitted to the End User by applicable laws and regulations of the End User's jurisdictions.

5. **NON-PERMITTED USES.** Without the express prior written permission of Kaltech Enterprises you may not (a) use, copy, modify, alter or transfer electronically or otherwise, the SOFTWARE or documentation except as expressly permitted in this License Agreement, or (b) translate, reverse program, disassemble, decompile, or otherwise reverse engineer the SOFTWARE.

6. **U.S. GOVERNMENT RESTRICTED RIGHTS.** If you are acquiring the SOFTWARE on behalf of any unit or agency of the United States Government, the following provision applies: It is acknowledged that the SOFTWARE and the documentation were developed at private expense and that no part is in the public domain and that the SOFTWARE and documentation are provided with RESTRICTED RIGHTS. Use, duplication, or disclosure by the Government is subject to restrictions as set forth in subparagraph (C)(1)(ii) of the Rights in Technical Data and Computer Software clause at DFARS 252.227-7013 or subparagraphs c (1) and (2) of the Commercial Computer Software-Restricted Rights at 48 CFR 52.227-19, as applicable. Contractor/Manufacturer is Kaltech Enterprises 5436 W Crenshaw St Tampa FL33634

7. **EXPORT CONTROLS.** Certain uses of the SOFTWARE by the End User maybe subject to restrictions under U.S. regulations relating to exports and ultimate end uses of computer software. The End User agrees to fully comply with all applicable U.S. laws and regulations, including but not limited to the Export Administration Act of 1979 as amended from time to time and any regulations promulgated there under.

8. **LIMITED WARRANTY.** (a) Kaltech Enterprises warrants to the End User, (i) that the SOFTWARE (not including any third-party software) will perform substantially in accordance with the associated documentation and (ii) that the SOFTWARE is properly recorded on the disk media. This Limited Warranty extends for (90) days from the date of purchase of this License. Kaltech Enterprises does not warrant any third-party software that is provided with the SOFTWARE, but Kaltech Enterprises agrees to pass on the End User any warranties of the owner of licensor to the extent permitted by the owner or licensor. (b) This Limited Warranty does not apply to any software that has been altered, damaged, abused, mis-applied, or used other than in accordance with this License and any instructions included on the SOFTWARE and the associated documentation. (c) Kaltech Enterprises's entire liability under this Limited Warranty shall be the repair or replacement of any SOFTWARE that fails to conform with this Limited Warranty or, at Kaltech Enterprises's option, the return price paid for this license. Kaltech Enterprises shall have no liability under this Limited Warranty unless the SOFTWARE is returned to Kaltech Enterprises or its authorized representative, with a copy of the End User's receipt, within the warranty period or 30 days, whichever is longer. (d) THIS WARRANTY IS IN LIEU OF AND EXCLUDES ALL OTHER WARRANTIES NOT EXPRESSLY SET FORTH HEREIN, WHETHER EXPRESS OF IMPLIED, SUBJECT TO CONTRARY ORDER PUBLIC REQUIREMENTS IN THE END USER'S JURISDICTION. (e) The End User's failure to return the enclosed registration card or complete the electronic registration included with the SOFTWARE may result in Kaltech Enterprises's inability to provide the End User with updates to the SOFTWARE, and the End User assumes the entire risk of performance and result in such an event.

9. CONFIDENTIALITY AND CONTROL OF THE SOFTWARE. The SOFTWARE, all associated documentation, and all copies are secret and confidential to Kaltech Enterprises and shall be retained under the effective control of the End User during the period of this License. The End User shall take all measures necessary to preserve confidentiality and secrecy in the SOFTWARE during the period of this License and after its termination, however such termination may arise.

10. INDEMNITIES AND LIMITATION OF LIABILITY. (a) Subject to 9(b) below, Kaltech Enterprises warrants to the End User that the Software as supplied by Kaltech Enterprises will not infringe any copyright, patent, or other intellectual property right of any third party. Conditionally upon the End User's promptly giving notice to Kaltech Enterprises of any claim of alleged infringement and allowing Kaltech Enterprises to have sole control of negotiations on, and any defense of the claim, Kaltech Enterprises shall in its discretion and at its own cost wither compromise or defend the claim and shall hold the End User harmless from any resulting final judgment, order, or settlement. Kaltech Enterprises shall have the right to replace or change the SOFTWARE so as to avoid infringement and require the End User to accept a license to use such replaced or changed SOFTWARE in substitution for this License, provided that the SOFTWARE as substituted is substantially suitable for the End User's utilization. (b) Kaltech Enterprises's maximum liability to the End User under 9(a) above shall not exceed the License fees actually paid by the End User for the SOFTWARE. If Kaltech Enterprises becomes aware of a potential claim under 9(a) above, Kaltech Enterprises shall be entitled then or at anytime thereafter to discharge its liabilities (including potential, accruing, and accrued liabilities) to the End User under 9(a) above by requiring the End User to surrender this License and to cease use of the SOFTWARE upon Kaltech Enterprises's paying to the End User a sum equivalent to the maximum amount of Kaltech Enterprises's liability as stated above. (c) GENERAL LIMITATION OF LIABILITY AND INDEMNITIES. KALTECH ENTERPRISES'S MAXIMUM LIABILITY RELATED TO ANY OF THE SOFTWARE SHALL NOT EXCEED THE LICENSE FEES ACTUALLY PAID BY THE END USER FOR THE SOFTWARE.

FOR BELGIUM, FRANCE, IRELAND, AND THE NETHERLANDS: IN NO EVENT SHALL KALTECH ENTERPRISES BE LIABLE TO THE END USER, EXCEPT IN RESPECT OF (a) DEATH, PERSONAL INJURY, OR DAMAGE TO PROPERTY CAUSED BY KALTECH ENTERPRISES'S NEGLIGENCE OR (b) KALTECH ENTERPRISES'S GROSS NEGLIGENCE OR WILLFUL MISCONDUCT, FOR AN AMOUNT IN EXCESS OF THE MAXIMUM AMOUNT OF KALTECH ENTERPRISES'S LIABILITY AS STATED IN 9(b) ABOVE, BY REASON OF ANY REPRESENTATION OR IMPLIED WARRANTY, CONDITION, OR OTHER TERM OR ANY DUTY AT LAW, OR UNDER THE TERMS OF THIS AGREEMENT, FOR ANY CONSEQUENTIAL LOSS OR DAMAGE (WHETHER FOR LOSS OF PROFIT, BUSINESS INTERRUPTION, LOSS OF BUSINESS INFORMATION, OR OTHERWISE) ARISING OUT OF OR IN CONNECTION WITH ANY ACT OR OMISSION OF KALTECH ENTERPRISES RELATING TO THE USE OR INABILITY TO USE THE PRODUCT BY THE END USER.

FOR GREECE: IN NO EVENT SHALL KALTECH ENTERPRISES BE LIABLE TO THE END USER, EXCEPT IN RESPECT OF DEATH, DAMAGE TO PROPERTY OR PERSONAL INJURY CAUSED BY KALTECH ENTERPRISES'S FRAUD OR GROSS NEGLIGENCE, FOR AN AMOUNT IN EXCESS OF THE MAXIMUM AMOUNT OF KALTECH ENTERPRISES'S LIABILITY AS STATED IN 9(b) ABOVE, BY REASON OF ANY REPRESENTATION OR IMPLIED WARRANTY, CONDITION, OR OTHER TERM OR ANY DUTY AT LAW, OR UNDER THE TERMS OF THIS

AGREEMENT, FOR ANY CONSEQUENTIAL LOSS OR DAMAGE (WHETHER FOR LOSS OF PROFIT, BUSINESS INTERRUPTION, LOSS OF BUSINESS INFORMATION, OR OTHERWISE) ARISING OUT OF OR IN CONNECTION WITH ANY ACT OR OMISSION OF KALTECH ENTERPRISES RELATING TO THE USE OR INABILITY TO USE THE PRODUCT BY THE END USER.

FOR ITALY: IN NO EVENT SHALL KALTECH ENTERPRISES BE LIABLE TO THE END USER, EXCEPT IN RESPECT OF DEATH, DAMAGE TO PROPERTY OR PERSONAL INJURY CAUSED BY KALTECH ENTERPRISES'S FRAUD OR GROSS NEGLIGENCE OR VIOLATION OF A DUTY ARISING FORM APPLICABLE ORDINE PUBBLICO RULES FOR AN AMOUNT IN EXCESS OF THE MAXIMUM AMOUNT OF KALTECH ENTERPRISES'S LIABILITY AS STATED IN 9(b) ABOVE, BY REASON OF ANY REPRESENTATION OR IMPLIED WARRANTY, CONDITION, OR OTHER TERM OR ANY DUTY AT LAW, OR UNDER THE TERMS OF THIS AGREEMENT, FOR ANY CONSEQUENTIAL LOSS OR DAMAGE (WHETHER FOR LOSS OF PROFIT, BUSINESS INTERRUPTION, LOSS OF BUSINESS INFORMATION, OR OTHERWISE) ARISING OUT OF OR IN CONNECTION WITH ANY ACT OR OMISSION OF KALTECH ENTERPRISES RELATING TO THE USE OR INABILITY TO USE THE PRODUCT BY THE END USER.

FOR DENMARK, FINLAND AND NORWAY: IN NO EVENT SHALL KALTECH ENTERPRISES BE LIABLE TO THE END USER, EXCEPT (i) IN RESPECT OF DEATH OR PERSONAL INJURY CAUSED BY KALTECH ENTERPRISES'S GROSS NEGLIGENCE OR WILLFUL MISCONDUCT OR (ii) IF SUCH LIABILITY LIMITATION IS UNREASONABLE UNDER ALL RELEVANT CIRCUMSTANCES, FOR AN AMOUNT IN EXCESS OF THE MAXIMUM AMOUNT OF KALTECH ENTERPRISES'S LIABILITY AS STATED IN 9(b) ABOVE, BY REASON OF ANY REPRESENTATION OR IMPLIED WARRANTY, CONDITION, OR OTHER TERM OR ANY DUTY AT LAW, OR UNDER THE TERMS OF THIS AGREEMENT, FOR ANY CONSEQUENTIAL LOSS OR DAMAGE (WHETHER FOR LOSS OF PROFIT, BUSINESS INTERRUPTION, LOSS OF BUSINESS INFORMATION, OR OTHERWISE) ARISING OUT OF OR IN CONNECTION WITH ANY ACT OR OMISSION OF KALTECH ENTERPRISES RELATING TO THE USE OR INABILITY TO USE THE PRODUCT BY THE END USER.

FOR PORTUGAL: IN NO EVENT SHALL KALTECH ENTERPRISES BE LIABLE TO THE END USER, EXCEPT IN RESPECT OF DEATH, DAMAGE TO PROPERTY OR PERSONAL INJURY CAUSED BY KALTECH ENTERPRISES'S GROSS NEGLIGENCE OR WILLFUL MISCONDUCT, FOR AN AMOUNT IN EXCESS OF THE MAXIMUM AMOUNT OF KALTECH ENTERPRISES'S LIABILITY AS STATED IN 9(b) ABOVE, BY REASON OF ANY REPRESENTATION OR IMPLIED WARRANTY, CONDITION, OR OTHER TERM OR ANY DUTY AT LAW, OR UNDER THE TERMS OF THIS AGREEMENT, FOR ANY CONSEQUENTIAL LOSS OR DAMAGE (WHETHER FOR LOSS OF PROFIT, BUSINESS INTERRUPTION, LOSS OF BUSINESS INFORMATION, OR OTHERWISE) ARISING OUT OF OR IN CONNECTION WITH ANY ACT OR OMISSION OF KALTECH ENTERPRISES RELATING TO THE USE OR INABILITY TO USE THE PRODUCT BY THE END USER.

FOR SPAIN: IN NO EVENT SHALL KALTECH ENTERPRISES BE LIABLE TO THE END USER, EXCEPT IN RESPECT OF DEATH, DAMAGE TO PROPERTY OR PERSONAL INJURY CAUSED BY KALTECH ENTERPRISES'S BAD FAITH CONDUCT, FOR AN AMOUNT IN EXCESS OF THE MAXIMUM AMOUNT OF KALTECH ENTERPRISES'S LIABILITY AS STATED IN 9(b) ABOVE, BY

REASON OF ANY REPRESENTATION OR IMPLIED WARRANTY, CONDITION, OR OTHER TERM OR ANY DUTY AT LAW, OR UNDER THE TERMS OF THIS AGREEMENT, FOR ANY CONSEQUENTIAL LOSS OR DAMAGE (WHETHER FOR LOSS OF PROFIT, BUSINESS INTERRUPTION, LOSS OF BUSINESS INFORMATION, OR OTHERWISE) ARISING OUT OF OR IN CONNECTION WITH ANY ACT OR OMISSION OF KALTECH ENTERPRISES RELATING TO THE USE OR INABILITY TO USE THE PRODUCT BY THE END USER.

FOR SWEDEN: IN NO EVENT SHALL KALTECH ENTERPRISES BE LIABLE TO THE END USER, EXCEPT IN RESPECT OF DEATH, DAMAGE TO PROPERTY OR PERSONAL INJURY CAUSED BY KALTECH ENTERPRISES'S GROSS NEGLIGENCE OR WILLFUL MISCONDUCT, FOR AN AMOUNT IN EXCESS OF THE MAXIMUM AMOUNT OF KALTECH ENTERPRISES'S LIABILITY AS STATED IN 9(b) ABOVE, BY REASON OF ANY REPRESENTATION OR IMPLIED WARRANTY, CONDITION, OR OTHER TERM OR ANY DUTY AT LAW, OR UNDER THE TERMS OF THIS AGREEMENT, FOR ANY CONSEQUENTIAL LOSS OR DAMAGE (WHETHER FOR LOSS OF PROFIT, BUSINESS INTERRUPTION, LOSS OF BUSINESS INFORMATION, OR OTHERWISE) ARISING OUT OF OR IN CONNECTION WITH ANY ACT OR OMISSION OF KALTECH ENTERPRISES RELATING TO THE USE OR INABILITY TO USE THE PRODUCT BY THE END USER.

FOR THE UNITED KINGDOM: IN NO EVENT SHALL KALTECH ENTERPRISES BE LIABLE TO THE END USER, EXCEPT IN RESPECT OF (a) DEATH OR PERSONAL INJURY CAUSED BY KALTECH ENTERPRISES'S NEGLIGENCE OR (b) DAMAGE TO PROPERTY OR OTHER LOSS CAUSED BY KALTECH ENTERPRISES WHERE SUCH LIABILITY LIMITATION IS UNREASONABLE UNDER ALL RELEVANT CIRCUMSTANCES, FOR AN AMOUNT IN EXCESS OF THE MAXIMUM AMOUNT OF KALTECH ENTERPRISES'S LIABILITY AS STATED IN 9(b) ABOVE, BY REASON OF ANY REPRESENTATION OR IMPLIED WARRANTY, CONDITION, OR OTHER TERM OR ANY DUTY AT LAW, OR UNDER THE TERMS OF THIS AGREEMENT, FOR ANY CONSEQUENTIAL LOSS OR DAMAGE (WHETHER FOR LOSS OF PROFIT, BUSINESS INTERRUPTION, LOSS OF BUSINESS INFORMATION, OR OTHERWISE) ARISING OUT OF OR IN CONNECTION WITH ANY ACT OR OMISSION OF KALTECH ENTERPRISES RELATING TO THE USE OR INABILITY TO USE THE PRODUCT BY THE END USER

11. NO LIABILITY FOR DAMAGES, INCLUDING WITHOUT LIMITATION CONSEQUENTIAL DAMAGES

In no event shall Kaltech Enterprises or its Licensor's be liable for any damages whatsoever (including, without limitation, incidental, direct, indirect, special or consequential damages, damages for loss of business profits, business interruption, loss of business information, or other pecuniary loss) arising out of the use or inability to use this Software, even if Kaltech Enterprises or its Licensor's have been advised of the possibility of such damages. Because some states/ countries do not allow the exclusion or limitation of liability for consequential or incidental damages, the above limitation may not apply to you.

12. NO WAIVER. Any failure by either party to this agreement to enforce a specific part of the agreement in a specific situation is not a waiver of rights under the agreement. The party may still enforce the rest of the agreement in that situation and may still enforce some or all of the agreement in other situations.

13. This License constitutes the entire agreement between the End User and KALTECH

ENTERPRISES pertaining to its subject matter. This License is governed by the laws of the State of Washington (except the body of laws controlling conflict laws). The state and federal courts having appropriate jurisdiction over the State of Washington will pursue any litigation arising from this license. Even if part of the agreement is held invalid, the rest of the agreement shall still be valid, binding, and enforceable. The failure of either party to exercise a right does not waive future exercise of that right or other rights.

Should the End User have any questions concerning this License, or if the End User desires to contact Kaltech Enterprises for any reason, please write: Kaltech Enterprises 5436 W Crenshaw St Tampa Fl 33634

Copyright© 2001, Kaltech Enterprises All rights reserved.
Safety Precautions

Safety Precautions



WARNING: TO REDUCE THE RISK OF ELECTRICAL SHOCK, DO NOT EXPOSE THIS APPLIANCE TO RAIN OR MOISTURE. DANGEROUS HIGH VOLTAGES ARE PRESENT INSIDE THE ENCLOSURE. DO NOT OPEN THE CABINET. REFER SERVICING TO QUALIFIED PERSONNEL ONLY.

SURGE PROTECTION: A UPS IS MANDATORY FOR EFFICIENT FUNCTIONING OF YOUR DIGITAL .

IMPORTANT SAFETY INSTRUCTIONS

1. Read Owner Manual

After unpacking this product, read the owner manual carefully, and follow all the operating and other instructions.

2. Power Sources

This product should be operated only from the type of power source indicated on the label. If you are not sure of the type of power supply to your home or business, consult your product dealer or local power company.

3. Ventilation

Slots and openings in the cabinet are provided for ventilation and to ensure reliable operation of the product and to protect it from overheating, and these openings must not be blocked or covered. The product should not be placed in a built-in installation such as a bookcase or rack unless proper ventilation is provided or the manufacturer instructions have been adhered to.

4. Heat

The product should be situated away from heat sources such as radiators. Heat registers, stoves, or other product that produce heat.

5. Water and Moisture

Do not use this product near water. Do not exceed the humidity specifications for the product as detailed in the Appendix section in this manual.

6. Cleaning

Unplug this product from the wall outlet before cleaning. Do not use liquid cleaners or aerosol cleaners. Use a damp cloth for cleaning.

7. Power Cord Protection

Power-supply cords should not be routed so that they are not likely to be walked on or pinched by items placed against them, paying particular attention to cords at plugs, convenience receptacles, and the point where they exit from the product.

8. Overloading

Do not overload wall outlets; extension cords, or integral convenience receptacles as this can result in a risk of fire or electrical shock.

9. Lightning

For added protection for this product during storm, or when it is left unattended and unused for long periods of time, unplug it from the wall outlet. This will prevent damage to the product due to lightning and power line surges.

10. Object and Liquid Entry Points

Never insert foreign objects into the DW-Pro unit, other than the media types approved by Kaltech Enterprises, as they may touch dangerous voltage points or short-out parts that could result in a fire or electrical shock. Never spill liquid of any kind on the product.

11. Accessories

Do not place this product on an unstable cart, stand, tripod, bracket, or table. The product may fall, causing serious personal injury and serious damage to the product.

12. Disc Tray

Keep your fingers well clear of the disc tray as it is closing. Neglecting to do so may cause serious personal injury.

13. Burden

Do not place a heavy object on or step on the product. The object may fall, causing serious personal injury and serious damage to the product.

14. Disc

Do not use a cracked, deformed, or repaired disc. These discs are easily broken and may cause serious personal injury and product malfunction.

15. Damage Requiring Service

Unplug this product from the wall outlet and refer servicing to qualified service personnel under the following conditions.

- When the power Supply cord or plug is damaged.
- If liquid has been spilled, or objects have fallen into the product.
- If the product has been exposed to rain or water.
- If the product does not operate normally by following the operating instructions. Adjust only those controls that are covered by the operating instructions as an improper adjustment of other controls may result in damage and will often require extensive work by a qualified technician to restore the product to its normal operation.
- If the product has been dropped or damaged in any way.
- When the product exhibits a distinct change in performance – this indicates a need for service.

16. Servicing

Do not attempt to service this product yourself as opening or removing covers may expose you to dangerous voltage or other hazards. Refer all servicing to qualified personnel.

17. Replacement Parts

When replacement parts are required, be sure the service technician has used replacement parts specified by the manufacturer or have the same characteristics as the original part. Unauthorized substitutions may result in fire, electrical shock, or other hazards.

18. Safety Check

Upon completion of any service or repairs to this product, ask the service technician to perform safety checks to determine that the product is in proper operating condition.

19. UPS / Surge Protection

A UPS is mandatory for efficient functioning of your Digital Watchdog unit.

Notes on Handling

- When shipping the DW-Pro unit, the original shipping carton packing materials come in handy. For maximum protection, repack the unit as it was originally packed at the factory.
- Do not use volatile liquids, such as insect spray, near the DW-Pro unit. Do not leave rubber or plastic products in contact with the DW-Pro unit for long periods of time. They will leave marks on the finish.
- The top and rear panels of the DW-Pro unit may become warm after long periods of use. This is not a malfunction.

Notes on Locating

- Place the DW-Pro unit on a level surface. Do not use it on a shaky or unstable surface such as a wobbling table or inclined stand.
- When you place this DW-Pro unit next to a TV, radio, or VCR, the playback picture may become poor and the sound may be distorted. In this case, place the DW-Pro unit away from the TV, radio, or VCR.

Notes on Cleaning

Use a soft dry cloth for cleaning.

- For stubborn dirt, soak the cloth in a weak detergent solution, wring well and wipe. Use a dry cloth to wipe it dry. Do not use any type of solvent, such as thinner and benzene, as they may damage the surface of the DW-Pro unit.
- If you use a chemical saturated cloth to clean the unit, follow that product's instructions.

Notes on Maintenance

This DW-Pro unit is designed to last for long periods of time. To keep your DW-Pro unit always operational we recommend regular inspection maintenance (cleaning parts or replacement). For details contact your nearest dealer.

Note on Moisture Condensation

Moisture condensation damages the DW-Pro unit. Please read the following carefully.

Moisture condensation occurs during the following cases.

- When you bring the DW-Pro unit directly from a cold place to a warm place.
- When you use the DW-Pro unit in a room where you just turned on the heater, or a place where the cold wind from the air conditioner directly hits the unit.
- In the summer, when you use the DW-Pro unit in a hot and humid place just after you move the unit from an air conditioned room.
- When you use the DW-Pro unit in a humid place.

Do not use the DW-Pro unit when moisture condensation may occur.

If you use the DW-Pro unit in such a situation, it may damage discs and internal parts. It is not recommended to use the Digital Watchdog in a location where moisture condensation may occur.

Warranty Information

Kaltec Electronics (referred to as “the Warrantor”) warrants the Digital Video Recorder against defects in materials or workmanship as follows:

LABOR: For a period of (1) year from the date of original purchase, if Digital Video Recorder is determined to be defective, Kaltec will repair or replace the unit, with new or refurbished product at its option, at no charge.

PARTS: In addition, Kaltec Electronics will supply replacement parts for a period of (1) year.

To obtain warranty or out of warranty service, please contact a Technical Support Representative at 1-866-446-3595 Ext 242 Monday through Friday from 9:00 AM to 5:00 PM Eastern.

This warranty is extended only to the original purchaser. A purchase receipt or other proof of the date of the original purchase is required before warranty service is rendered. This warranty only covers failures due to defects in materials and workmanship which arise during normal use. This warranty does not cover damage which occurs in shipment or failures which are caused by products not supplied by the Warrantor or failures which result from accident, misuse, abuse, neglect, mishandling, misapplication, alteration, modification, faulty installation, set-up adjustments, improper antenna, inadequate signal pickup, maladjustment of consumer controls, improper operation, power line surge, improper voltage supply, lightning damage, rental use of the product or service by anyone other than a Digital Video Recorder authorized repair facility or damage that is attributable to acts of God.

LIMITS AND EXCLUSIONS

There are no express warranties except as listed above. THE WARRANTOR SHALL NOT BE LIABLE FOR INCIDENTAL OR CONSEQUENTIAL DAMAGES (INCLUDING, WITHOUT LIMITATION, DAMAGE TO RECORDING MEDIA) RESULTING FROM THE USE OF THESE PRODUCTS, OR ARISING OUT OF ANY BREACH OF THE WARRANTY. ALL EXPRESS AND IMPLIED WARRANTIES, INCLUDING THE WARRANTIES OF MERCHANTABILITY AND FITNESS FOR PARTICULAR PURPOSE, ARE LIMITED TO THE APPLICABLE WARRANTY PERIOD SET FORTH ABOVE.

Some states do not allow the exclusion or limitation of incidental or consequential damages, or limitations on how long an implied warranty lasts, so the above exclusions or limitations may not apply to you. This warranty gives you specific legal rights and you may also have other rights that vary from state to state.

If the problem is not handled to your satisfaction, then write to the Address above.

SERVICE CALLS WHICH DO NOT INVOLVE DEFECTIVE MATERIALS OR WORKMANSHIP AS DETERMINED BY THE WARRANTOR, IN ITS SOLEDISCRETION, ARE NOT COVERED. COSTS OF SUCH SERVICE CALLS ARE THE RESPONSIBILITY OF THE PURCHASER.

Caution

Please beware of the following precautions before installing the DVR.





- Avoid positioning the DVR in any place where the unit may come into contact with moisture, dust, or soot.
- Avoid placing in direct sunlight or near heating appliances.
- Keep the product away from electric shock or magnetic substances.
- Avoid temperature extremes (recommended operation temperature is between 0°C and ~40°C).
- Do not place any conductive material through the ventilation grills.
- Keep the system turned off before installation.
- Ensure enough space is left for cable connections.
- Place the system on a solid surface with sufficient air ventilation. Avoid any surface that vibrates.
- Placing the system near electronic devices such as radio or TV may cause breakdown to the product.
- Do not disassemble the product.
- Do not place any heavy object on the system.

Safety Warnings and Cautions

The following are warnings and cautions for the safety of the users and for the prevention of any property damage. Please read below thoroughly.

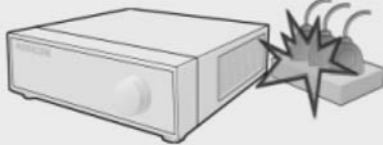
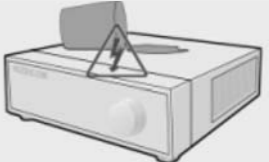
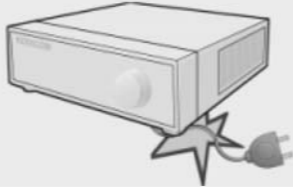
Warning and Caution signs

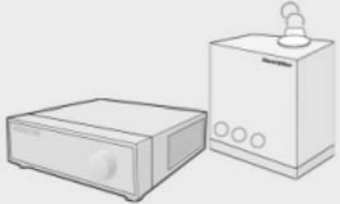
 Warning If you are not aware of this warning, you may be seriously injured or be killed.	 Caution If you are not aware of this caution, you may be injured or cause property loss.
---	---

 Warning	
<p>Turn off the system before installing the system. Do not plug in several electric devices to the same outlet.</p> <ul style="list-style-type: none">• This may cause heating, fire, or electric shock. 	<p>Do not place any liquid container on the system, such as water, coffee, or beverage.</p> <ul style="list-style-type: none">• If liquid is poured onto the system, it can cause a system breakdown or cause fire. 
<p>Prevent power cable from being severely bent or pressed by a heavy object.</p> <ul style="list-style-type: none">• This may cause fire. 	<p>Clean the dust around the system on regular basis. When cleaning the system, always use dry cloth. Do not use wet cloth or other organic solvents.</p> <ul style="list-style-type: none">• This may damage the surface of the system and can cause system breakdown or electric shock. 
<p>Avoid any place with moisture, dust, or soot.</p> <ul style="list-style-type: none">• This can cause fire or electric shock. 	<p>When pulling the power cable from the plug, do so gently. Do not touch the plug with wet hands and avoid using the plug if the holes on the outlet are too loose.</p> <ul style="list-style-type: none">• This may cause fire or electric shock. 

 **Warning**

Do not attempt to disassemble, repair, or modify the system on your own. It is extremely dangerous due to high voltage running through the system.

- This may cause fire, electric shock, or serious injuries.

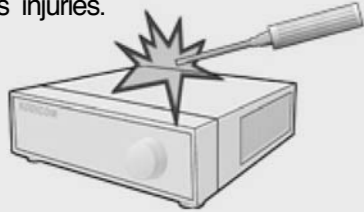

Install the system in a cool place without direct sunlight and always maintain room temperature. Avoid candle light and heat-generating devices such as heater. Keep the system away from places where many people pass.

- This may cause fire.

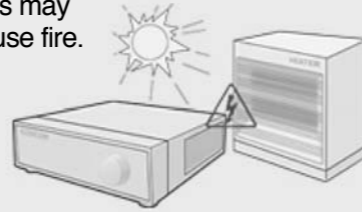

Check for any danger signs such as moist floor, loosened or damaged power cable, or unstable surface. If you encounter any problems, ask for assistance from your dealer.

- This may cause fire or electric shock.

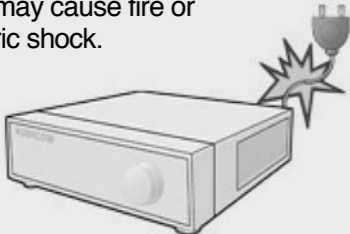

Install the system on a plain surface with sufficient air ventilation. Do not place the system on elevated surface.

- This may cause system breakdown or serious injuries.



Keep at least 15cm between the back of the system and a wall for the cables connected into the system. Otherwise, cables may be bent, damaged, or cut.

- This may cause fire, electric shock, or injuries.



The power outlet must be placed on a ground, and the voltage range must be within 10% of the voltage rate. Do not use the same outlet with a hair dryer, iron, refrigerator, or any heating appliances.

- This may cause fire, heating, an electric shock.



 **Warning**

When the system's battery is depleted, you must change it with the same or equivalent type of battery specified by the manufacturer. Depleted batteries should be discarded according to manufacturer's instructions.

- This may cause an explosion.

If the system's HDD exceeded its life span, you may not be able to recover any data stored inside the HDD. If the video on the system screen appears 'damaged' while playing a recording stored inside the system's HDD, it must be replaced with a new one. Ask for an engineer's assistance for HDD replacement from your dealer.

Caution

Do not install the system in a place with high magnetic, electric wave, or wireless devices such as radio or TV.

- Install the system in a place without magnetic objects, electric frequencies, or vibration.



Install the system in a place with appropriate moisture and temperature level.

- Avoid installing the system with high (over 40°C) or low (under 0°C) temperature.

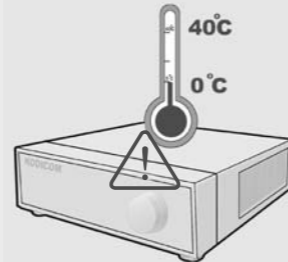

Prevent any substances from being inserted into the system.

- This may cause system breakdown.

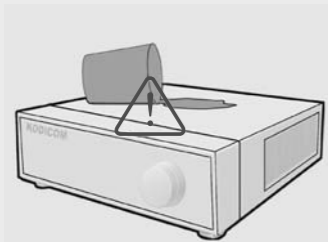

Do not place any heavy object on the system.

- This may cause system breakdown.

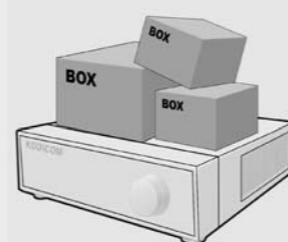

Install the system in a place with sufficient air ventilation.

- Keep at least 15cm distance between the back of the system and a wall, and at least 5cm distance between the side of the system and a wall.

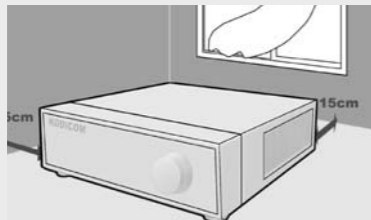

Install the system on a stable and leveled surface.

- The system may not operate properly.



Caution

The system can be damaged from a strong impact or vibration. Avoid throwing objects within the vicinity of the system.

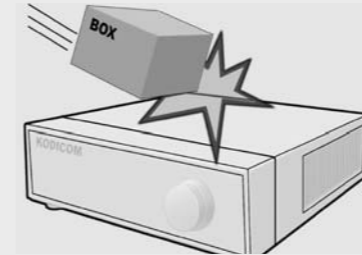

The outlet must be placed on the ground.

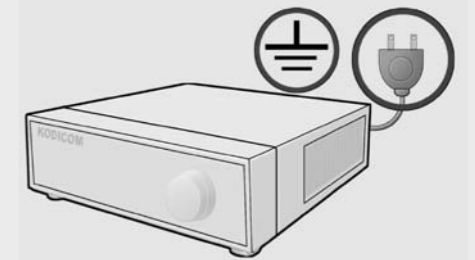

Avoid direct sunlight or any heating appliances.

- Recommended operating temperature is over 0°C(32°F)

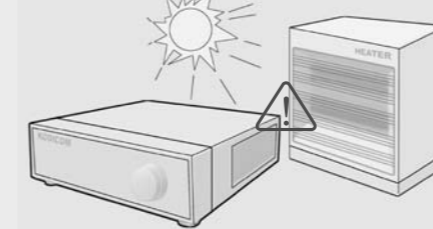

If there is strange sound or smell, unplug the power cable immediately and contact the service center.

- This may cause fire or electric shock.

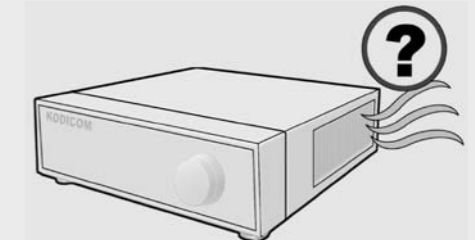

Ventilate the air inside the system operation room, and tighten the system cover firmly.

- System breakdown may be caused by inappropriate environment.

It is recommended to use AVR (Automatic Voltage Regulator) for stable power supply.

It is recommended to coil the core-ferrite around the connector of the system to avoid electromagnetic interference.

In order to maintain stable system performance, have your system checked regularly by the service center.

- Risk of explosion if battery is replaced by an incorrect type. Dispose of used batteries according to the instruction.

Caution

Do not overturn the product under use.

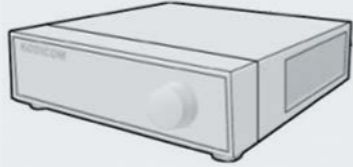

Power Set up



Connect with AC115V if AC selector is as left picture.



Connect with AC230V if AC selector is as left picture.

Equipment

Please check to make sure the following equipment are included when you purchased DVR. If any items are missing, contact your dealer.

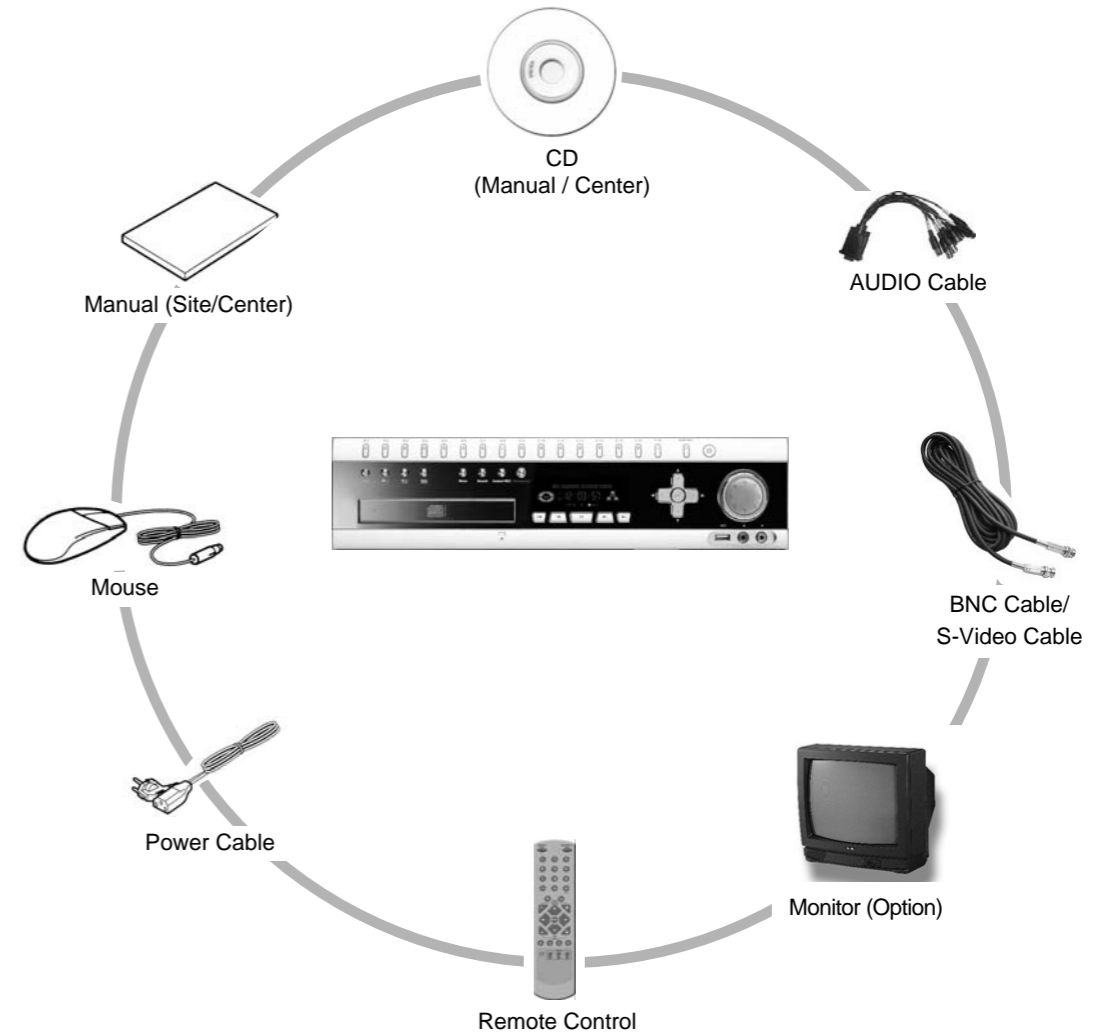

Contents

Chapter 1. Guide

1. System Overview

1.1 Front panel	3
1.2 Rear panel	7
1.3 Description of the Remote Controller	11

2. Surveillance mode

2.1 Screen Layout	12
2.2 Enabling full screen & sequence modes	13

3. Menu operation

3.1 Using menu in live mode	14
3.2 Using menu on PAN/TILT mode	15
3.3 Using menu on playback mode	16

4. Pan/Tilt Camera

4.1 Switching to Pan/Tilt control mode	17
4.2 Pan/Tilt Camera Control	18
4.3 Supported Pan/Tilt Camera list	19

5. Search

5.1 Accessing Search mode	20
5.2 Search mode display	20
5.2.1 Graph color display	21
5.3 Selecting date and time	22
5.3.1 Selecting date	22

Contents

5.3.2 Selecting cameras and changing graph bar line	23
5.3.3 Audio Output	24
5.3.4 Playback	25

6. Backup

6.1 Saving backup into local drive	27
6.1.1 Still image backup	27
6.1.2 Video backup	28
6.2 Saving backup using remote drive	32
6.3 Printing still image	35

7. System Setup

7.1 Accessing Setup mode	36
7.2 Setup menu	36
7.3 System Setup	38
7.3.1 Password	38
7.3.2 Site Information	41
7.3.3 Software Upgrade	43
7.3.4 Log Information	44
7.3.5 OSD / Dwell Time	47
7.3.6 System management	48
7.3.7 System Shutdown	60

Contents

7.4 Recording Setup	62
7.4.1 Recording Setup	62
7.4.2 Motion detection	63
7.4.3 Motion Link setting	64
7.4.4 Schedule	65
7.4.5 Quality/Resolution	66
7.5 Camera Setup	67
7.5.1 Channel Setting	68
7.5.2 Sensor setting	69
7.5.3 Sensor/Control link	70
7.5.4 Sensor/Camera link	71
7.5.5 Spot Out/Camera link	72
7.6 Network Setup	73
7.7 Backup Schedule	82
7.7.1 Adding Backup schedule	83
7.7.2 Deleting Backup schedule	88
8. Controls - Manual Control	
8.1 Switching to Control Mode	89

Chapter 2. Installation

1. Pan/Tilt Connection

2. Connecting LAN/PSTN Communication Lines

2.1 LAN, ISDN (with the Router), and Dedicated Line Connection	94
2.2 PSTN (telephone line) Connection (optional)	95

3. RX Receiver (KRE-303) Connection Diagram (optional)

3.1 Name of Each Part and Description	97
---	----

4. External Sensor Connection (Input)

5. Control Port Connection (Output)

6. Adding HDD

6.1 Installing new HDD	100
6.2 Checking HDD Database	101

7. HDD Smart Check

7.1 HDD Smart Check	102
---------------------------	-----

8. External Storage Setup

9. Formatting External Storage

Appendix

1. Viewer
2. WebDVR
3. Specifications
4. FAQ
5. Product Warranty

1. Guide

1. System Overview
2. Surveillance mode
3. Menu Operation
4. Pan/Tilt Camera
5. Search
6. Backup
7. System Setup
8. Controls - Manual Control

1. System Overview

1.1 Front Panel

The following describes the keys and ports on the front of the system and their functions :

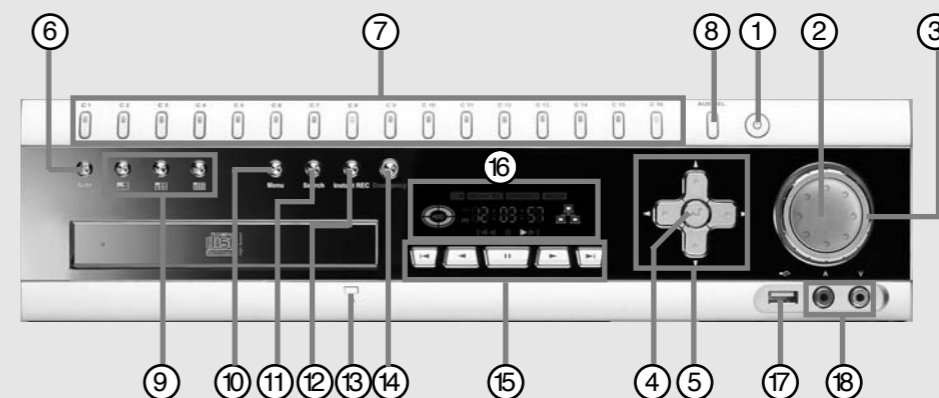

[Figure 1-1. System front view]

① [Power]

- Use this button to turn the DVR on/off.
- Three seconds after power is supplied, the system is booted automatically.
- To turn off the DVR, press the power button, When prompted for the password, enter the password and click the [OK] button.

② [Jog(inner dial)]

- Rotate to view recordings, in Search mode, forwards or backwards one frame at a time.
- Rotate to change the value of options one unit at a time in Setup mode.
- When controlling P/T/Z camera, rotate to shift camera lens focus.

③ [Shuttle(outer dial)]

- Rotate to play the recordings, in Search mode, forward or backwards.

- Rotate to change the value of options continuously in Setup mode.
- When controlling P/T/Z camera, rotate to zoom in or out.

④ [Enter Key]

- Use to select options in Setup or Search mode.
- Use to directly go to Control setup mode from the Surveillance mode.

⑤ [Directional Keys]

- Use to move through the menu options in Setup or Search mode.
- When controlling P/T/Z camera, press the directional keys to move the camera.
- When searching recorded image, you can adjust the size of the image using up and down directional key.

⑥ [Auto]

- Press to begin automatic channel sequence either in full or multi screen modes.



⑦ [Camera/Number keys]

- In Surveillance mode, press for full screen display of that camera.
- In Search mode, press for full screen display of that camera recording during playback.
- Press the keys to enter correct numeric password when accessing Setup or Search modes.
- With video input, the camera burns yellow without video input, however, the camera button does not light up.

⑧ [Split screen buttons]

- To output live audio data on the surveillance screen, press the [AUD SEL.] button and the applicable camera button whose live audio data are to be outputted. [AUD SEL.] turns green, and the selected camera button turns red.
- Selecting the [AUD SEL.] button causes it to function as a live audio selection button.
- To exit the audio mode and to select video data, press the [AUD SEL.] button again.

⑨ [Split screen buttons]

- On Surveillance or Search modes, press to select 4-splitscreen , 9-splitscreen  or 16 -splitscreen .

⑩ [Auto]

- To go to the system configuration window, press the [Menu] button. You will then be asked to enter the administrator's password. To exit the current menu or to close the configuration window, press the [Menu] button.

⑪ [Search]

- To go to the search window, press the [Search] button. You will then be asked to enter the administrator's password.

⑫ [Instant REC]

- In case of an emergency, press the [Instant REC] button. Use the [Instant REC] button to record video data from all cameras regardless of the recording schedule. In the LED status window, "Instant REC" turns yellow.
- To cancel instant recording, press the [Instant REC] button again.

☞ [Note]

- Selecting the instant recording feature causes video data to be recorded according to the number of recording frames and audio data recording set for each camera.

⑬ [CD-RW Open]

- Press button to open CD-RW.

⑭ [Emergency]

- Use this button to send video data to a remote location or an e-mail address in case of an emergency.
- During emergency transmission, "Emergency" is displayed in yellow on the LED status window. (For more information on the [Emergency] button, see "Emergency Warning" in "7.6 Network Setup.")

⑮ [Search mode control Keys]

- In Search mode, use these keys to view the recording from either the first or last recorded image, to play the recording either forwards or backwards, to pause viewing the recording.

⑯ [LED Status windows]

- The LED status window displays the current operating state of the DVR.

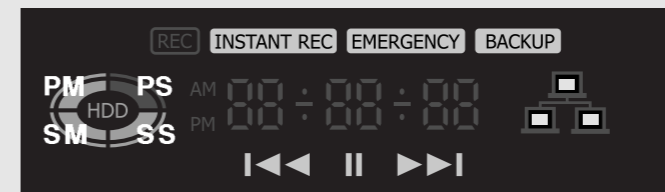

< HDD Type >

- PM : Primary Master
- PS : Primary Slave
- SM : Secondary Master
- SS : Secondary Slave



: The access state and access count vis-a-vis the HDD installed in the system are displayed. When the HDD is in normal state, this button turns orange; in case of bad sector or overheating, however, this button turns red.



: Indicates that a recording is in progress



: Displayed when the [Instant REC] button is pressed

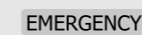

: Displayed when the [Emergency] button is pressed

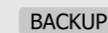

: Displayed when recorded video data are being backed up



: Displays the current time



: Displayed when images are replayed on the search window



: Displayed when the center accesses the system, or data are backed up remotely

⑰ [USB Port]

- You can connect a portable disk drive to USB port to save backup of recorded video.
- You can update your system software with an upgrade package through the USB port.
- A standard HP PostScript computer printer can be connected to USB port of DVR to print out any still image.

☞ [Note] Removable Disk

- The table below lists compatible USB disks. If you want to use other removable disk, it should be compatible with Linux 2.4.0 or over. Other USB disk may not work properly.
- It is recommended that you confirm through the manufacturer the Linux compatibility of the removal disk you wish to purchase.
- The USB disk should be formatted as FAT 32. DVR dose not supports NTFS or other file systems.
- When the memory of the portable USB disk is partitioned, or a password has been set, the system will not recognize the disk. Combine partitions in the memory and unlock the password before connecting the disk to the system.
- Since some USB HDDs do not generate power at all or generate only low-voltage power, a separate power source is required for such USB HDDs to enable the system to recongnize them.
- Only when the memory of the USB HDD is formatted as the main partition will the system recognize the USB HDD. If it is formatted as an extension partiton, however, the system will not recognize the USB HDD.

*Removable Disk support

No.	Name	Company	USB Version
1	AnyDrive	AL-tech	Ver 1.1
2	Unidrive	KMIT	Ver 1.1
3	Nexdrive	JUNGSOFT	Ver 1.1
4	SHELLGINO N4	SHELLGINO	Ver 1.1
5	TRANSCEND JF A 128M	Transcend	Ver 1.1

*Removable HDD support

No.	Name	Company	USB Version
1	HD 335	Nudian	Ver 1.1
2	FireWire HDD 20G	lomega®	Ver 2.0
3	FireWire HDD 40G	lomega®	Ver 2.0

⑭ [A/V Output]

- Used to connect the audio/video output port to the audio/video input port of the TV or monitor.

1.2 Rear panel

The following describes keys and ports on the rear part of the system and their functions.

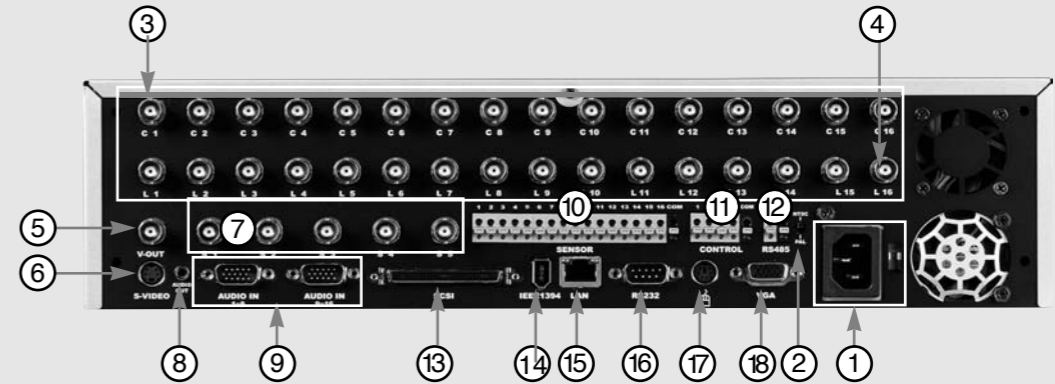

[Figure 1-2. System rear view]

① [Power Connector]

- Power cable input, 110V ~ 220V, for system main power Supply.

⚠ [Caution]

- Be careful of electrocution. Please read [Safety Warnings and Cautions]

② [NTSC/PAL Setup]

- The DVR supports both NTSC and PAL formats. Before turing on the DVR, select the NTSC or PALVideo format.

③ [Camera Image Input]

- Used to send camera image to the BNC port through the coaxial cable.

④ [Loop Through Output]

- Video output ports for camera loop through to view image to another monitor or device.
- The system supports both NTSC and PAL.

[Caution]

- Dependant on the grounding status of the power supply electric current that can cause an electric shock may flow in the video line (coaxial cable). Turn off the system before connecting the video line to the BNC port.

⑤ [V-Output Port]

- Video output for connecting with CVBS monitor.

⑥ [S-Video Output Port]

- S-Video output for connecting with SVGA monitor.

⑦ [Spot Monitor Output]

- Up to 5 Spot monitors can be connected to the Spot output port. Spot Output Ports S1~S5 select the intended image of cameras and output them on the Spot monitor. (For more information on the interworking settings of the camera whose video data are outputted to the Spot monitor, See "7.5.5 Spot Out/Camera Link".)

⑧ [Audio Out]

- Connects the speakers to the Audio Out port in order to output Audio data.

Note

- The DVR is not equipped with an audio output amplifier. Thus, user are advised to purchase separate amplifiers and speakers or speakers with a built-in amplifier.

⑨ [AUDIO IN]

- Connects the port to the audio cable.
- Connect the audio input to as many as 16 channels.
- Supports recording of up to 16 audio channels.

⑩ [Sensor Input Port]

- External sensor inputs for channels 1~16.
- The system supports NC and NO sensor types.

⑪ [Control Output Port]

- Control output for connecting control devices for channels 1~4.

[Caution]

- Since control devices use output in a contact point format without polarity at the control output port, do not connect AC 110V ~ 220V of the power cable or supply DC power.
- When controlling DC power, it is recommended that you cut the (-ve) line.

⑫ [RS-485 Output Port for P/T/Z Control]

- RS-422/RS-485 output for controlling P/T/Z cameras.

⑬ [SCSI]

- Before starting the system, connect the SCSI equipment and ensure power supply. Then, boot system to use the SCSI equipment as the 'recording device' or 'backup device'. You can define the SCSI ID between 0 and 15 (except 7) and install up to 8 SCSI equipments.

⑭ [IEEE1394]

- To use an IEEE1394 external hard disk as the 'recording device' or 'backup device', connect it to the system.

⑮ [LAN]

- Ethernet 10/100Mbps connection port for remote access.
- To access the network through the network hub, connect the network cable to the LAN port.
- You can remotely monitor, search, and control data on the network.

⑯ [External modem terminal] NOT AVAILABLE IN EUROPEAN MODELS

- Provide a connection to the external modem for a remote access.
- You can remotely monitor, search, and control data through modem access.

⑰ [Mouse]

- PS/2 mouse connection port.
- Using the mouse, you can set the surveillance and search screen and configure the system.
- The scroll wheel of the mouse has the same function as the Jog/Shuttle button of the DVR.

[Note] Support for Scroll Mouse

- The scroll mouse types supported by the system are listed in the table below. Scroll mouse types other than those listed below may not be supported by the system. Please check.

- Applicable Wheel Mouse List.

No.	Mouse Name	Model Name or Type	Support wheel feature	Place of Manufacture
1	SOLID YEAR	SYW1320 SOLID YEAR	YES	China
2	A4TECH	SWW-35	YES	China
3	SAMSUNG	SMP2000WX	YES	CHIC TECH/China
4	TriGem	M-S48a	YES	Logitech(China)

⑱ [VGA]

- Connect the VGA monitor to the VGA port.
- Displays images on the VGA monitor.

1.3 Description of the Remote Controller

The following describes the remote controller buttons, which have the same functions as the buttons on the front panel of the system:

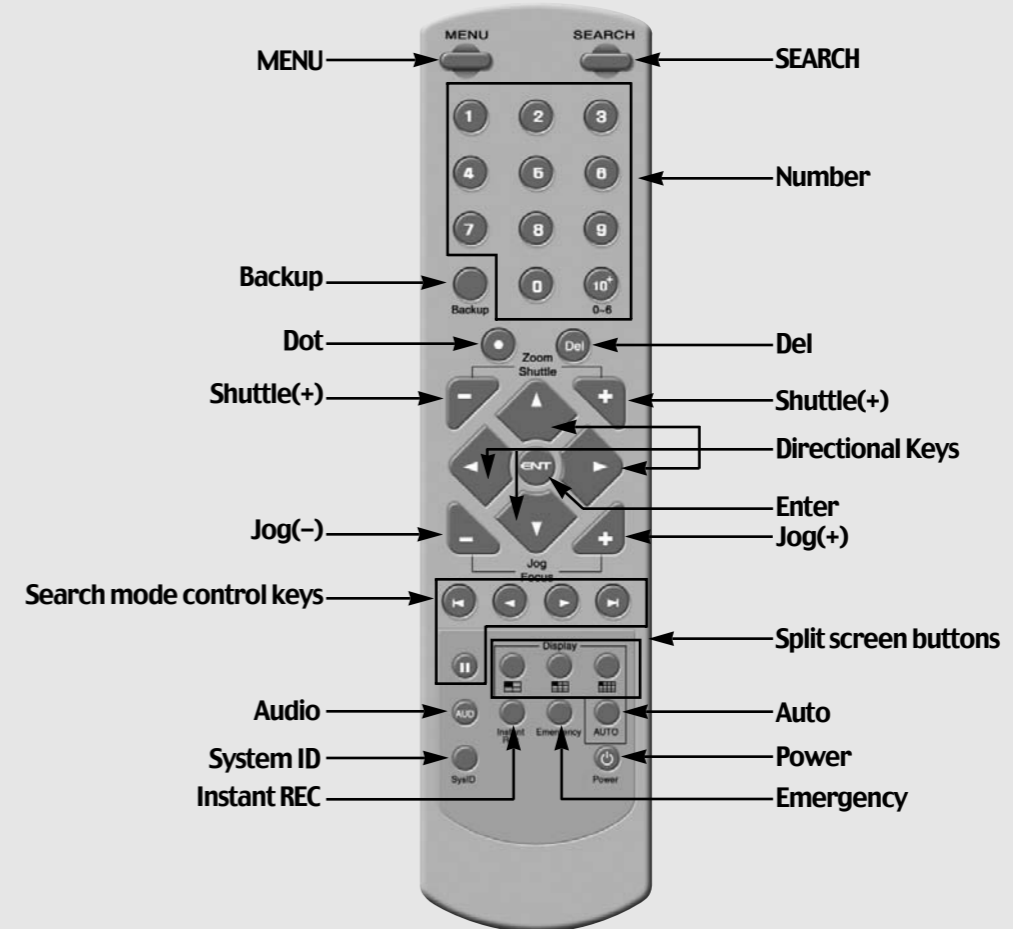

☞ [Note]

- To select camera 10~16, press the **10*** button followed by the **0** ~ **6** buttons.
- The **[Backup]** button is enabled on search. To go to the backup screen, press the **[Backup]** button.
- **[Sys ID]** Set the ID of remote control using the **[SysID]** button. Refer "System ID " on page 54 for more details.

2. Surveillance Mode

2.1 Screen Layout



[Figure 2-1. Main Surveillance Mode by 4 split screen]

① **[Camera Number]**

- Displays camera number.
- For the live audio output channel, the camera number turns red.

② **[Camera Name]**

- Displays camera name.

③ **[Recording Status]**

- Displays camera recording mode enabled

④ **[P/T/Z Status]**

- Displays Pan/ Tilt camera status enabled.

⑤ **[Audio Recording Status]**

- Shows audio recording enabled.

Recording Mode	Available Recording Modes and Screen Display	
• C : Continuous Recording • M : Motion Recording • S : Sensor Recording • P : Pre-alarm Recording	• No recording	No Display
	• Continuous Recording	Red 'R'
	• Motion Recording	Orange 'R'
	• Sensor Recording	
	• Motion & Sensor Recording	
	• Motion & Pre-alarm Recording	
	• Sensor & Pre-alarm Recording	
• Motion & Sensor & Pre-alarm Recording		
• Instant Recordig	Black 'R'	

[Table 2-1. Available Recording Modes and Screen Display]

2.2 Enabling full screen and sequence modes



[Figure 2-2. Full screen mode]

[To Select Full Screen mode]

- Press any key 1~16 on the system to enlarge that camera channel and view in full screen.

[To Select Quad screen]

- Press the 4-split screen button to select quad display of cameras 1-4. Press again to move to next quad screen.

[To Select 9 way split screen]

- Press the 9-split screen button to select display of cameras 1-9. Press again to move to next 9 way screen.

[To Select 16 way split screen]

- Press the 16 way split screen button to view all cameras on one screen.

[Sequence]

- When full screen is selected, press the Auto key to view all camera channels in sequence. The system will also sequence between quad and 9 way displays. (see page 47 - OSD/Dwell Time for details on changing Auto option).



[Figure 2-3. 9-splitscreen mode]



[Figure 2-4. 16-splitscreen mode]

3. Menu Operation

3.1 Using menu in live mode

Pop-up menu appears when you click right mouse button on surveillance, search or Pan/Tilt mode



[Figure 3-1. Pop-up menu operated by mouse on surveillance mode]

① [MENU]

- Main menu for system setup
- When using mouse, click on 'Menu' icon to go to Setup.
- When using front panel, press 'MENU' button on the front panel.

② [SEARCH]

- Click on "SEARCH" to go to Search mode.
- When using front panel, press "SEARCH" button.

③ [CONTROL]

- Click on "CONTROL" to go to Control menu.
- When using front panel, press "OK" button.

④ [AUTO]

- To go to auto display mode, select single,

quad or 9 channel split screen.

- Press auto display icon to get auto rotation screen. Click to view live image in single, quad, 9ch, and 16ch modes.

⑤ [Multi Screen]

- You can get 4, 9 or 16 channel display screen with clicking the icon by mouse or pressing the front panel key.

⑥ [Volume Control]

- You can adjust the volume or mute the sound.
- To adjust the system volume, adjust the volume on the popup menu.

☞ [Notice] Right mouse click

- Click right mouse button to activate or deactivate pop-up menu in the surveillance mode.

3.2 Using menu on PAN/TILT mode

This menu appears by selecting a full channel that supports P/T camera in surveillance mode.



[Figure 3-2. Pop-up menu on Pan/Tilt mode]

① [PTZ]

- Button to go to Pan/Tilt control mode.
- Select any channel that supports Pan/Tilt camera. If you click right mouse button on the image, it changes to full screen.

② [Pan/Tilt]

- Controls the Pan/Tilt camera in Pan/Tilt mode

③ [ZOOM IN/OUT]

- Zoom in or out any supported Pan/Tilt or Speed Dome type camera.

④ [FOCUS IN / OUT]

- Adjust focus of the camera lens.
(This function is not supported on any auto focus cameras)

☞ [Notice] Right mouse click

- Use right mouse click to enter into or exit from the Pop-up menu.

3.3 Using menu on playback mode

This menu appears only when you click right mouse button while playing back recorded images. (See page 25 for how to playback of recorded images.)



[Figure 3-3. Mouse pop-up menu on multiple channel playback screen]



[Figure 3-4. Mouse pop-up menu on single channel playback screen]

- ① Click this button to start backup. (Refer to page 27 for details of backup procedure)
- ② Click this button to select time and date to search.

- ③ **[Playback button]**
 - (From the left) First recorded image / play backward / pause / play forward / Last recorded image (See page 26 Table for details)
- ④ **[Direction Key]**
 - Using left and right arrow key, you can play backward or forward on frame by frame rate.
 - Using up and down arrow key, you can increase or decrease the size of playback image.

4. Pan/Tilt Camera

4.1 Switching to Pan/Tilt control mode



[Figure 4-1. Enlarged P/T/Z channel]

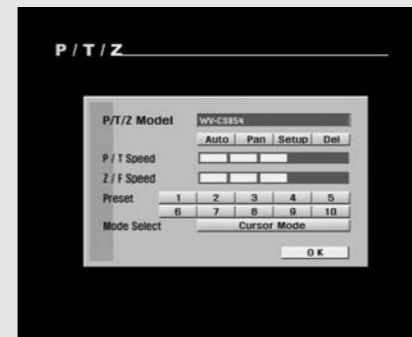

[Figure 4-2. P/T/Z control mode]

[Pan/Tilt Camera Control]

- Select the camera channel connected to the P/T/Z camera by using the mouse or camera number keys on the front panel. This will display the channel in full screen mode.
- Once the channel is enlarged, press [Enter] to access [P/T/Z control mode]. Pan/Tilt controls may differ depending on the connected camera model.

[Exiting P/T/Z control mode]

- When you have finished with this screen, click [OK] button by mouse or press MENU on the front panel to return to Surveillance mode.

4.2 Pan/Tilt Camera Control

In P/T/Z menu, you can switch the P/T/Z camera controls to manual control, as well as changing Zoom, Focus, and Auto Pan settings.

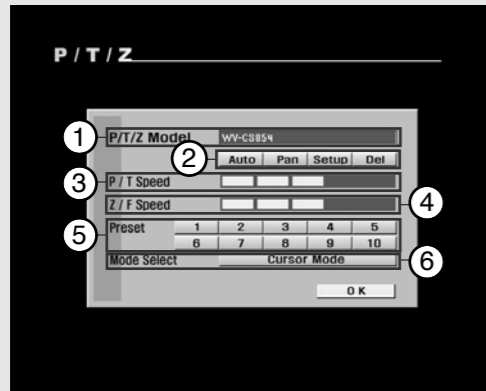

[Figure 4-3. P/T/Z menu]

① [P/T/Z Model]

- Displays the P/T/Z camera model.

② [P/T/Z function buttons]

- You can enable or disable P/T/Z camera functions by selecting the options you wish to use by using the mouse or the [Directional] and [Enter] key on the front panel.
- Some functions may differ depending on the P/T/Z camera model you are using.

③ [P/T Speed]

- Use the directional keys on the system to set the speed of the movement of the Speed Dome camera when it is to be controlled manually.
- P/T Speed only applies if you are using a Speed Dome camera.

④ [Z/F Speed]

- Use the jog/shuttle on the system to set the camera zoom/focus rate.
- Z/F Speed only applies if you are using a Speed Dome camera.

⑤ [Preset]

- If you have a Speed Dome camera configured with presets, selection of a numbered button will move the camera to that preset position (see [Mode Select] below).
- Preset selection only applies if you are using a Speed Dome camera.

⑥ [Mode Select]

- Mode button is used to set the Speed Dome camera to a preset position.
- Select the [Cursor Mode] button using the [Directional] keys, then press [Enter] to change to [P/T Mode].
- To set the position of the Speed Dome camera to Preset buttons, change the [Cursor Mode] to [P/T Mode], then move the camera position using the directional keys. Once the camera is in the designed position, change the [P/T Mode] back into [Cursor Mode].

4.3 Supported Pan/Tilt Camera List

No.	Manufacturer	Model Name	P/T	P/T Speed	Zoom	Focus	Z/F Speed	Preset	Manual Control and other functions	IRIS	BPS
1	LG	LVC-M500	NO	NO	YES	YES	YES	NO	YES	NO	9600
2	LG	LPT-OI500	YES	YES	YES	YES	YES	YES	YES	NO	9600
3	LG	LPT-EP500	YES	YES	YES	YES	YES	YES	YES	NO	9600
4	CANNON	VCC50i	YES	YES	YES	YES	YES	YES	NO	NO	9600
5	NIKO	NK-97 SD	YES	YES	YES	YES	NO	YES	YES	NO	9600
6	SAMSUNG	SPD-1600 SD	YES	YES	YES	YES	YES	YES	YES	NO	9600
7	SAMSUNG	SCC-641	YES	YES	YES	YES	NO	YES	YES	NO	9600
8	PANASONIC	WV-CS854	YES	YES	YES	YES	YES	YES	YES	NO	9600
9	DONG-YANG	DRX-501A	YES	NO	YES	YES	NO	NO	YES	NO	9600
10	SUNG-JIN	CCR-20G RX	YES	NO	YES	YES	NO	NO	YES	NO	4800
11	PELCO	PELCO-D SD	YES	YES	YES	YES	NO	YES	YES	NO	2400
12	PELCO	C1489M-D SD	YES	YES	YES	YES	NO	YES	YES	NO	2400
13	HONEYWELL	GC-755	NO	NO	YES	YES	YES	YES	NO	NO	9600
14	PHILIPS	LTC SD	YES	YES	YES	YES	YES	YES	NO	NO	9600
15	ORION	KRE-303	YES	NO	YES	YES	NO	NO	YES	NO	2400
16	TOA(CBC)	C-CC554 SD	YES	YES	YES	YES	YES	YES	YES	NO	19200
17	ITA	ITA-MPC1	YES	YES	YES	NO	YES	YES	YES	NO	9600
18	Vision	Vision360v1	YES	YES	YES	NO	NO	YES	YES	NO	9600
19	HITRON	FASTRAX	YES	YES	YES	YES	NO	YES	YES	NO	9600
20	SAMSUNG	SCC-93IT	NO	NO	YES	YES	YES	YES	YES	NO	9600
21	DONG-YANG	DSC-203	YES	YES	YES	YES	YES	YES	YES	NO	9600
22	Sensomatic	Sensomatic	YES	NO	YES	YES	NO	YES	YES	NO	4800
23	CTN	HD-0670	YES	YES	YES	YES	YES	YES	YES	NO	9600
24	Commax	commax rx	YES	NO	YES	YES	NO	NO	YES	NO	9600
25	Chilsung	CRD-J6416	YES	NO	YES	YES	NO	NO	YES	NO	19200
26	DONG-YANG	DY-255RXB	YES	NO	YES	YES	NO	NO	YES	NO	9600
27	DONG-YANG	DY-SPS360D	YES	YES	YES	YES	NO	YES	YES	NO	9600
28	Intern	CRX-1401 RX	YES	NO	YES	YES	NO	NO	YES	NO	9600
29	Yaan	Yaan SD	YES	YES	YES	YES	NO	YES	YES	NO	4800
30	SAMSUNG	MRX100	YES	NO	YES	YES	NO	NO	YES	NO	9600
31	UNIMO	KRX-3200 RX	YES	NO	YES	YES	NO	NO	NO	NO	9600
32	UNIMO	KRX-2101 RX	YES	NO	YES	YES	NO	NO	YES	NO	2400
33	ELMO	Ptz200c	YES	YES	YES	YES	YES	YES	NO	NO	9600
34	ELMO	Ptz400c	YES	YES	YES	YES	YES	YES	NO	NO	9600
35	KODICOM	KRE-301 RX	YES	NO	YES	YES	NO	NO	YES	NO	9600

[Table 4-1. Supported Pan/Tilt camera list]

5. Search

5.1 Accessing Search Mode

To access Search mode, press **Search** button on the system. The login window will then be displayed, enabling the inputting of user ID and password as shown below.

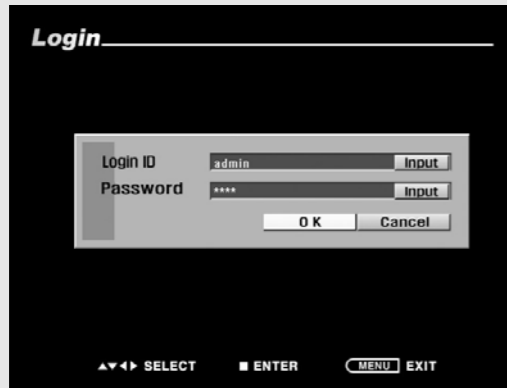

[Figure 5-1. Login screen]



- First, click the **[Input]** button to enter the desired user ID and password.
(The Admin account initially has no password.)
- Enter the desired user ID and password and click the **[OK]** button. The system setup screen is then displayed as shown below.
- To return to Surveillance mode, press **[Search]** button at anytime.

5.2 Search mode display

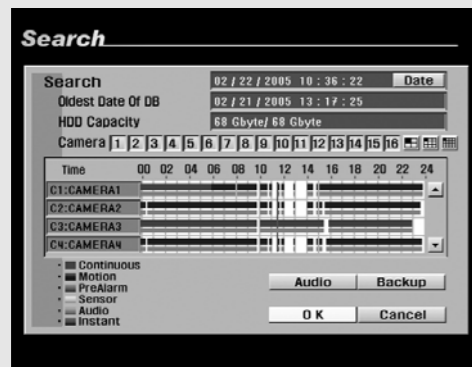
After you enter the correct password, the Search mode display will appear as shown below. You can select from the different options by using the mouse or the [directional] keys.



[Figure 5-2. Search mode display]





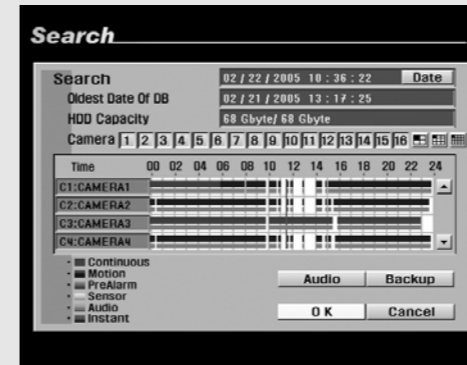

- In Search mode display, you can select the time and date and the camera channels you wish to view.
- To choose the date you wish to view, select the **[Date]** button. This will display a calendar. From there, select the day you wish to view (see pages 22 for details).
- The recording for each camera will be displayed in the time graph.
- If a camera is connected to an Audio input, the system will replay both video and audio at the same time.
- After selecting the time, date and camera number, press **[OK]** button to view the recording.
- Press the **[Up]** and **[Down]** ( ) arrow button to select any channel to search.

5.2.1 Graph color display



[Figure 5-3. Graph color display]

- Recorded data shown on the time graph will be displayed in different colour depending on the recording type enabled (see Table 5-1 below).

Color	Description	Display
• Purple	Continuous Recording	
• Blue	Motion-detection Recording	
• Green	Pre-alarm Recording	
• Orange	Sensor Recording	
• Red	Audio Recording	
• Black	Instant Recording	

[Table 5-1. Graph color description]

5.3 Selecting date and time

5.3.1 Selecting date

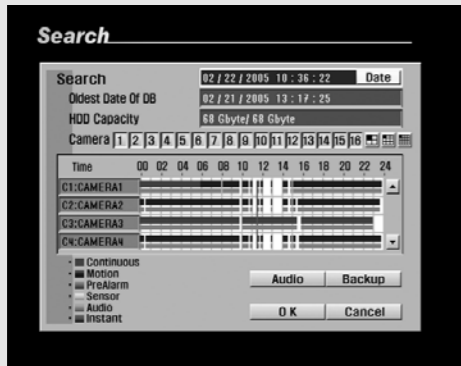

[Figure 5-4. Selecting [Date] button]

- To select the date you wish to view, use the directional keys to select **[Date]** button, then press **Enter**. This will display a calendar.



[Figure 5-5. Calendar display]

- [Changing Year/Month]**
 - Press the arrow buttons () above the calendar to change year/month.
- [Selecting Date]**
 - Use the directional keys to select the date and press **Enter**.
 - Dates containing recorded data are displayed in orange color (see table 5-2 for color descriptions).
- [Selecting Hour/Minute/Second]**
 - Use the shuttle Dial on the system or the mouse wheel to change hour/minute/second.

[Note] Jog and Shuttle Dial

- Jog** Dial: Changes hour/minute/second or any other setup value precisely.
- Shuttle** Dial: Changes hour/minute/second or any other setup value quickly.

Color	Description	Example
• Orange	Date with Recorded Data	10
• Red	Holidays/Weekends	10
• Black	Date without Data	10
• Yellow Box	Selected Date	10
• Blue Box	Cursor Location	10

[Table 5-2. Calendar date colors]

5.3.2 Selecting cameras and changing search bar line

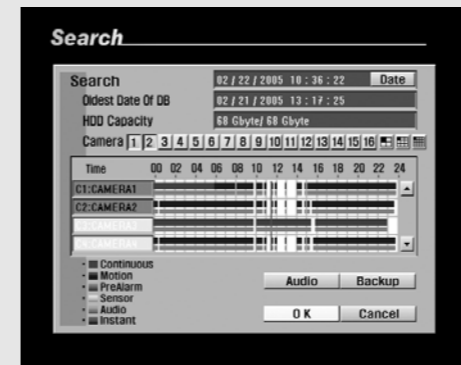

[Figure 5-6. Selecting cameras and graph bar line]

- After selecting the date you wish to view, press the **[OK]** button to return to Search mode display. The system will display the selected date's recording in the time graph.

[Oldest Data Of DB]

- Displays the initially saved date of the video data.

[HDD Capacity]

- Displays the total and used capacities of the Hard Disk Drive installed in the system.

[Camera]

- Select the camera to search for images by pressing the button on the system or using the mouse.
- To set the camera in segmented mode, click the button of 4, 9, or 16 segments.

[Changing graph bar line]

- To shift the search bar line, use the jog or shuttle dial on the system or the mouse wheel. This will shift the bar left or right. Shifting the search bar line will change the time of the recording you wish to view.

5.3.3 Audio Output

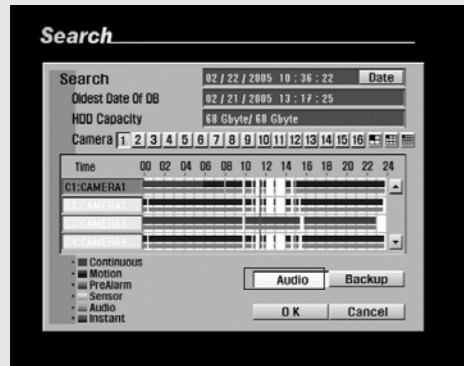

[Figure 5-7. Selecting audio]

[Audio]

- The system can play the video with any recorded sound, provided an audio recording device is connected to that channel.
- To play the recording with sound, use the mouse or the directional keys on the system to select the **[Audio]** button, then press **Enter**. Once selected, you will listen to any recorded audio.

[Note]

- Only one camera channel can output audio data for replay.
- Audio data are outputted only during forwarding, not during backwarding or fast replay.

5.3.4 Playback

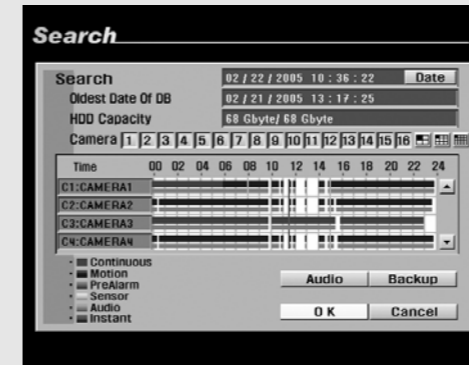

[Figure 5-8. Search mode display]

- Select the date (year, month, day and time) and camera number and click the **[OK]** button.

[Playback recorded data]

- After selecting the date, time, and the cameras, press **[OK]** button to play the recording using the mouse or the **Enter** key.







[Figure 5-9. Search mode playback]

[Full Screen]

- To enlarge a channel during playback, use the number keys 1~16 on the system to select the channel you wish to enlarge.
- When a channel is selected, use **▲▼** (**zoom in/zoom out**) keys to increase or decrease the screen size.







**[Caution]**

- Recording frame rate might vary depending on the number of installed camera or system load.

	Move to the very beginning of the date's recording
	Reverse Play
	Stop
	Forward Play
	Move to the very end of the date's recording

[Table 5-3. Search mode playback buttons]

[Replay Direction and Speed]

- To go back to previous images, press the  button. To fast backward images, press the  button again.
- To move on to next image, press the  button. To fast forward images, press the  button again.
- To replay images at normal speed, press the  or  button again.

[Conversion into the Initial Search Screen or Monitoring Screen]

- To return to Search mode display, press to the Enter button at anytime.
- To shift from the replay to the surveillance screen press the **[Search]** button.

6. Backup**6.1 Saving backup to local drive**

From Search screen display, select **[Backup]** button to save a backup copy of the recording using the system's IEEE1394, CD-RW, USB HDD, or a portable hard drive such as USB memory stick. The backup files can be saved as AVI, BMP, JPEG, or KDB formats.

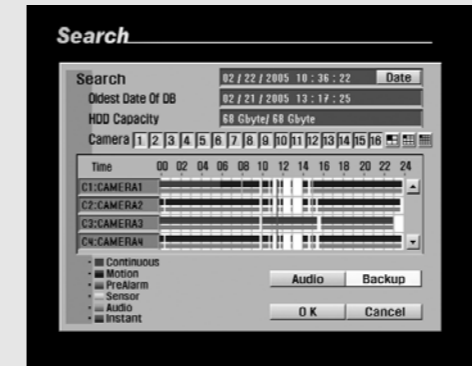
6.1.1 Still Image backup

[Figure 6-1. Selecting [Backup] button]

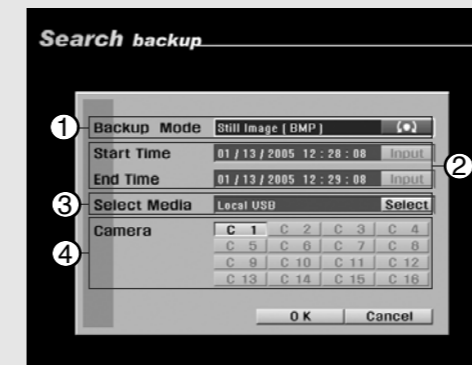

[Figure 6-2. Backup options display]

- To back up still images, replay the recorded image first and press the Enter once you reach the scene that you would like to back up. The initial search screen is then converted into the initial surveillance screen.
- To go to the initial backup screen, click the **[Backup]** button on the initial surveillance screen.

① [Backup mode - Still Image]

- To select BMP or JPEG backup mode, use the mouse wheel or the directional keys to highlight **[Backup Mode]** then use the jog/shuttle to change the option.

② [Start Time] and [End Time]

- The time and date input function is automatically disabled. The image saved will be the image selected and paused on the Search screen.

③ [Select Media]

- Select the media used for saving backup.
- When Still Image mode is selected, it is recommended to save to the Local USB drive.

④ [Camera]

- When Still Image mode is selected, only those cameras that were selected in Search mode will be saved. Camera channels that do not contain any data will be disabled.

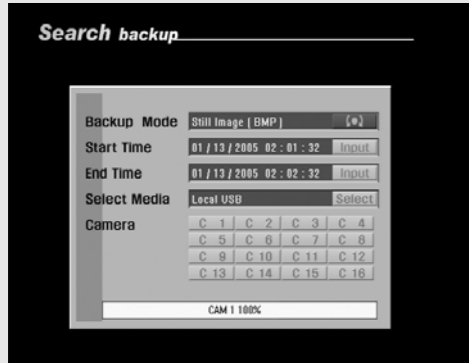

[Figure 6-3. Backup progress bar]

- Press **[OK]** button to begin backup. You will see the backup progress through the progress bar.
- Once backup is complete, the system will return to Search mode display.

③ [Select Media]

- Select the media used for saving backup.
- Press the **[Select]** button to choose different media types (see page 30 for details on selecting Local Drive backup).

④ [Camera]

- Select the camera number that contains the recording you wish to save.
- When saving backup in KDB format, you can select multiple camera channels.
- When saving backup in AVI format, you can only select one camera channel.
- When saving backup in Video mode, you will see  displayed on the corresponding camera channels in Surveillance mode.

[Note]

- To play a backup file saved in AVI format, the latest DivX Codec must be installed on the PC you are using. If you do not have DivX Codec installed, please use the Internet resources to download the required Codec.
- KDB backup enables to backup of the video with audio data. However, the other types of backup such as AVI, BMP, JPG do not include audio.
- When the is archived to CD-RW in KDB format the viewer software will be copied automatically to the CD. (For more information on the viewer program please refer to page 109.)

6.1.2 Video backup

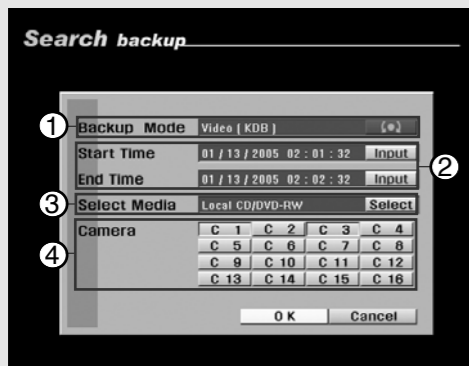

[Figure 6-4. Backup options display]

① [Backup mode - Video]

- To select KDB or AVI backup mode, use the mouse or the directional keys on the system to highlight **[Backup mode]**, then use the mouse wheel or the jog/shuttle to change the option.

② [Start Time] and [End Time]

- Select the starting time and ending time of the recording you wish to save.
- To change the **[Start Time]** and **[End Time]**, use the mouse or the directional buttons to highlight **[Input]** button, then click left mouse button or press **Enter**.



[Figure 6-5. Start Time]

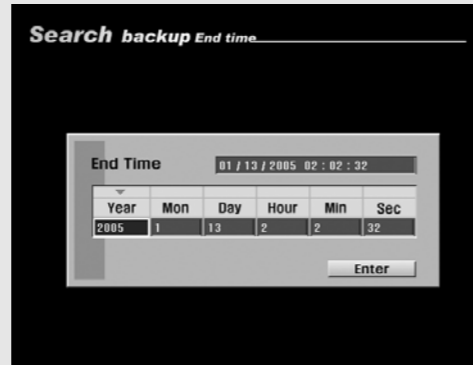

[Figure 6-6. End Time]

[Start Time] and [End Time] setup

- To select [Start Time] and [End Time], use the mouse or the directional keys to select the time and date, then use the mouse wheel or the shuttle to select the start and end times of the recording you wish to copy.
- Press **[Enter]** button to apply the select times.

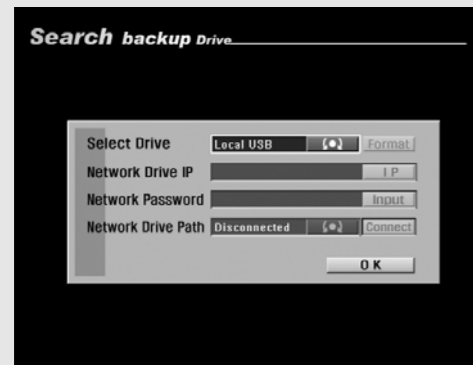

[Figure 6-7. Selecting Local Drive]

[Selecting Drive]

- Use the mouse wheel or the jog/shuttle to select Local USB, Local CD-RW, or Remote Drive.
- To save backup using a local drive, select Local USB or Local CD-RW (see page 33 for remote backup).
- USB Hard Disk Drive and USB memory stick can be connected to the USB port for back up. When saving backup using Local USB, the system will automatically scan for a connected USB drive.
- "Select Drive" is displayed only when the external storage (SCSI, IEEE1394) is set up as backup. To learn how to set up the use of external storage, refer to "External Storage" on page 55.



[Figure 6-8. Message on insufficient storage space]

[Storage space shortage]

- When the storage space for USB HDD or memory, CD-RW is running short, a warning message will be shown as left.
- A window will appear to ask whether to change backup media or not.
- **[Yes]**
Backup will start when you click **[Yes]** after changing the backup media.
- **[No]**
Backup will not progress when you click **[No]** and will go to the previous menu.

[Note]

- The DVR supports USB 2.0 and accommodates USB 1.0.
- It is possible to burn the image data onto CD-RW or CD-R media up to 100 times, but it varies depending on the image size.
- Recording speed might be slower while the backup using USB HDD, CD-RW, or remote backup is going on.
- Do not plug out the USB cable or turn off USB devices during backup. It may cause a problem in the system.

6.2 Saving backup using remote drive

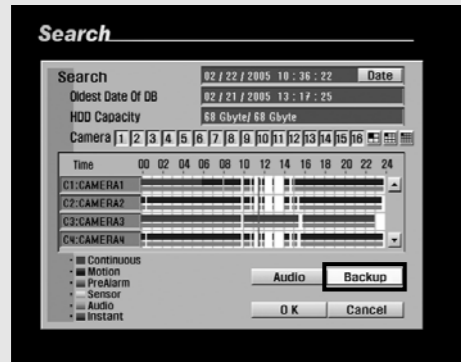

[Figure 6-9. Selecting [Backup] button]

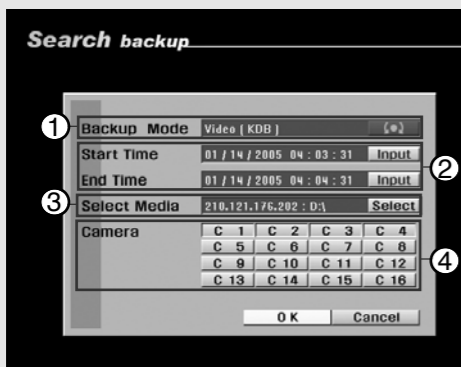

[Figure 6-10. Backup options display]

[Note]

- When saving a backup as a still image (JPEG or BMP), you cannot select Drive as backup.

- From Search screen, select **[Backup]** button to save a backup copy of the recording using a remote drive.

① **[Backup mode – Video]**

- To select KDB or AVI backup mode, use the **mouse** or the directional keys on the system to highlight **[Backup mode]**, then use the mouse wheel or the jog/shuttle to select the option.
- You can **only** select **Video mode** when backing up to a remote drive.

② **[Start Time] and [End Time]**

- Select the start time and end time of the recording you wish to backup.
- To change the **[Start Time]** and **[End Time]**, use the mouse or the directional buttons to highlight **[Input]** button, then click left mouse button or press **Enter**.

③ **[Select Media]**

- Select the media used for saving backup.
- Press the **[Select]** button to choose from different media types (see page 33 for details on selecting Remote Drive backup).

④ **[Camera]**

- Select the camera number that contains the recording you wish to save.
- When saving backup in KDB format, you can select multiple camera channels.
- When saving backup in AVI format, you can only select one camera channel.
- When saving backup in Video mode, you will see **GO** displayed on the corresponding camera channels in Surveillance mode.

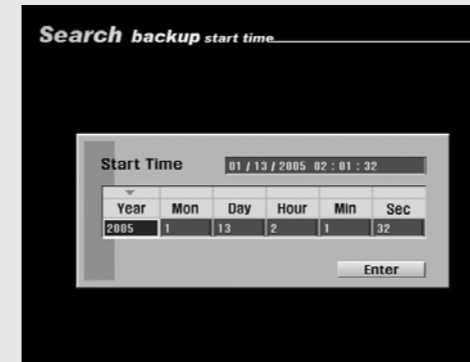

[Figure 6-11. Start Time]



[Figure 6-12. End Time]

[Start Time] and [End Time] setup

- To select **[Start Time]** and **[End Time]**, use the mouse or the directional keys to select the time and date, then use the mouse wheel or the jog/shuttle to select the start time and end time of the recording you wish to backup.
- Press **[Enter]** button to apply the selected times.

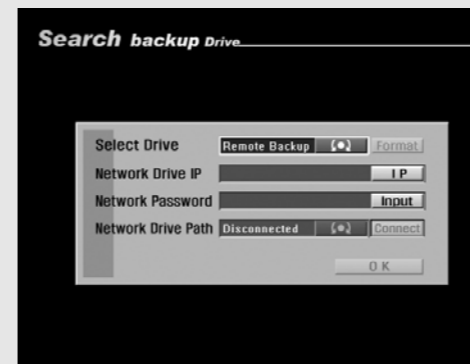

[Figure 6-13. Remote Drive setup]

[Select Media – Remote Drive]

- Use the mouse wheel or the jog/shuttle to select Remote Drive.
- If the system is connected through LAN or Internet line, you can save a remote drive backup by entering the correct IP address.
- When saving a remote drive backup, the receiving PC or fileserver must have Center Program installed with Backup Server Program running.
- To save a remote drive backup, you will need the IP address and the password of the receiving PC or fileserver.
- To enter IP address and password, use the directional keys to highlight **[Input]** button, then press **Enter**.



[Figure 6-14. Entering IP]



[Figure 6-15. Entering password]

[Network Drive IP] and [Network Password]

- To enter the Network Drive IP address and Network password, use the mouse or the directional keys and **Enter** button to select the numbers and letters. Press **[OK]** button to apply the selected IP address and password.

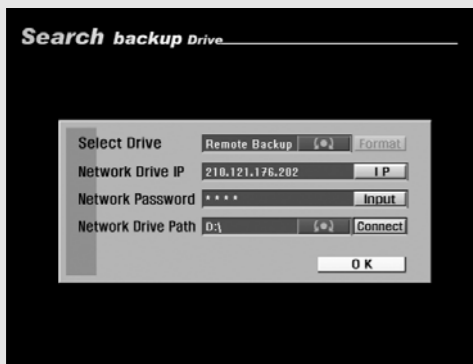

[Figure 6-16. Remote drive setup]

[Connecting]

- Press the **[Connect]** button to connect the system to the receiving PC or fileserver. Once connected, you will be able to select Network Drive path.
- Depending on the connection status, the system will display either "Connect", "Disconnect", or "Connect fail" message.

6.3 Printing Still Image

- It is possible to print out the recorded image using the printer that supports PostScript. Choose the camera to print out while playing back the recorded and press **[OK]**. If you click **[Backup]** button in the search screen below image will appear.

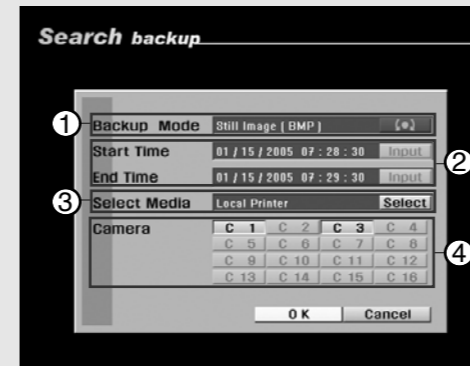

[Figure 6-17. Search Backup]

① [Save image]

- Select BMP or JPEG to print out in still image.
- Backup method can be selected by moving mouse pointer over backup mode menu and rolling wheel or using directional keys in the DVR.

② [Start Time] and [End Time]

- Time of the paused image will be shown.
- When Still Image mode is selected, **[Start Time]** and **[End Time]** will indicate the time when the selected frame is recorded. **[Input]** button will be disabled.

③ [Select Media]

- Use the **mouse** or the **directional** keys on the system to print a still image and then click **left mouse button** or press **Enter**
- Select Local Printer

④ [Camera]

- Select the camera number that contains the recording you wish to save.
- When printing out in BMP or JPEG only selected cameras during playback will be activated.

[Local Drive–Local Printer]

- Use the **mouse wheel** or the **jog/shuttle** on the system to select Local Printer and press **[OK]** button.

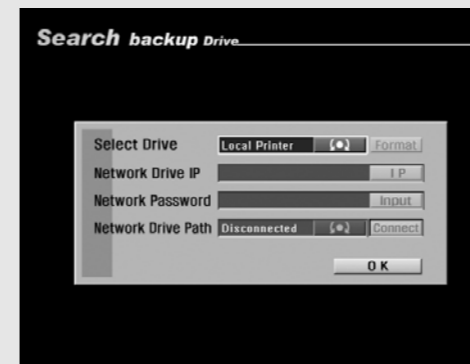

[Figure 6-18. Local Printer Selection]

7. System Setup

7.1 Accessing Setup mode

To go to the system setup screen, click the [MENU] button shown in the foreground of the system screen. The login window will then be displayed, enabling the inputting of user ID and password as shown below.

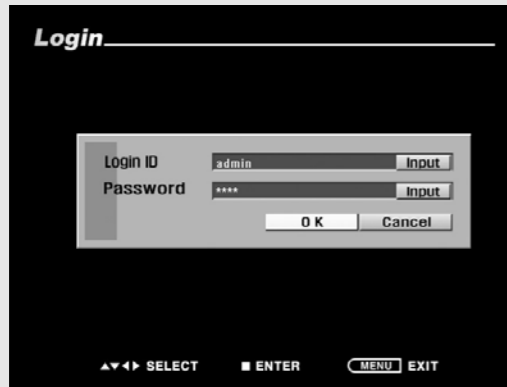

[Figure 7-1. Login screen]

- First, click the [Input] button to enter the desired user ID and password. (The Admin account initially has no password.)
- Enter the desired user ID and password and click the [OK] button. The system setup screen is then displayed as shown below.

7.2 Setup menu

Once you log on the system, the following initial screen for system setup is displayed. Use the mouse or direction buttons in the foreground of the system screen to go other menus.

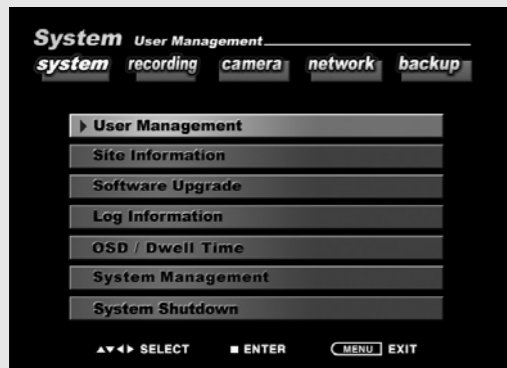

[Figure 7-2. Setup menu]

User management: This is the function for managing the user ID and password.

Main Menu	Setting Options	Description
• System Setup	User Management	Change and set user password, add new user, and user level setup.
	Site Information	Change site code, date display type, and time.
	Software Upgrade	Update system program
	Log Information	Show recorded log information
	OSD/Dwell Time	Turn OSD on/off, and set automatic channel rotation setting
	System management	Change system hardware settings
• Recording Setup	System Shutdown	Shutdown or restart the system
	Recording setup	Set brightness, frame rate, and audio recording.
	Motion Detection	Set motion detection area and beep sound of each camera.
	Recording Schedule	Select recording mode and set camera schedule
• Camera Setup	Quality / Resolution	Set the recording channel size and resolution.
	Channel Setting	Lets you select the use and name of the camera and PTZ model.
	Sensor Setting	Set sensor connection to the system.
• Communication Setup	Sensor/Control link	Change sensor and control connection and options.
	Spot Out/Camera link	Set the camera whose data are to be outputted on the spot monitor.
	Network	Select network type.
	D/PASSWORD	Logging in ADSL require ID/PASSWORD.
• Backup Setup	Site IP	Enter IP address of the system.
	Subnet Mask	Enter subnet mask address of the system.
	Gateway	Enter gateway address of the system.
	Emergency Notification	Transmit video data to a remote location or an e-mail address in case of emergency.
	Backup Schedule	Setup automatic backup schedule

[Table 7-1. Setup menu options]

7.3 System Setup

7.3.1 User Management



[Figure 7-3. User Management]



[Figure 7-4. Password Setup]



[Figure 7-5. Changing the password]

- In the [System] menu, select the submenu titled [User Management]. The user management screen is then displayed.

- Use the mouse or jog/shuttle button in the system or mouse wheel buttons to go to the password Setup, User Addition, and Level Setup screens.
- You can change your own user password.

- Enter the old password in the [Old Password] field and new password in the [New Password] and [Confirm] fields, and then press the [OK] button. The old password is then changed to the new one you entered.

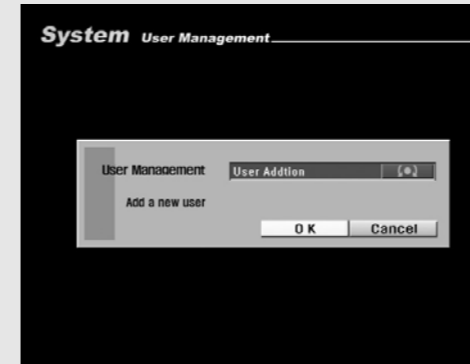

[Figure 7-6. User Addition]

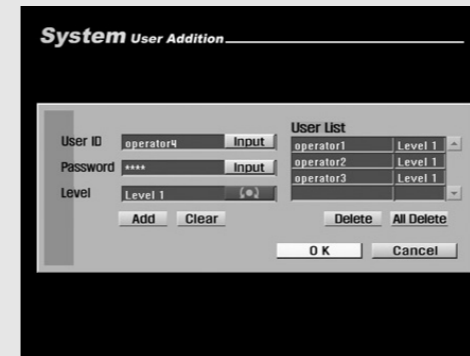

[Figure 7-7. Adding a user]

- To create a new user ID or delete any existing user ID, go to [User Addition] and click the [OK] button.

[Adding a User]

- To add a new user, enter the new user ID and password in the [User ID] and [Password] fields, respectively. Afterward, specify the user level in the [Level] field and click the [Add] button. The new user you entered is then registered in [User List]. (For details on level setting, see page 40.)
- To delete any data entered in the [User ID] and [password] fields, click the [Clear] button.

[Deleting a User]

- Select the user you want to delete in [User List] and click the [Delete] button. The selected user is then deleted.
- To delete all users registered in [User List], click the [Delete All] button. (The add/delete user function is supported only for the Admin account.)

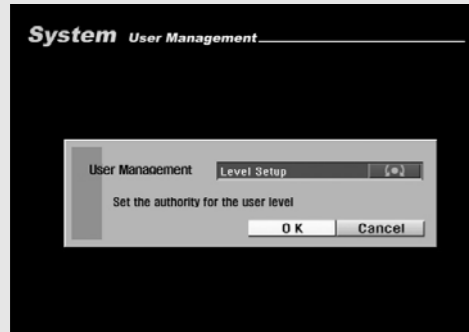

[Figure 7-8. Level Setup]

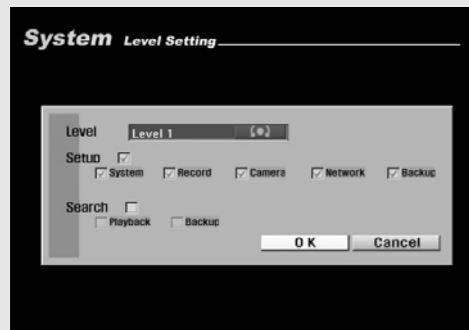

[Figure 7-9. Level setting]

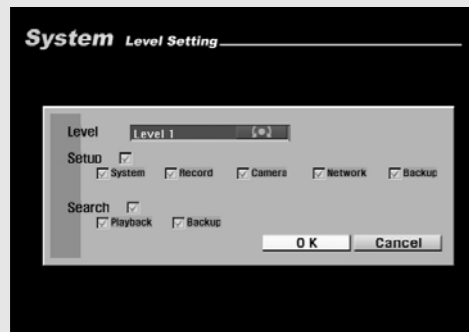

[Figure 7-10. Level setting]

- To set up the user level in each step, go to the [Level Setup] menu and click the [OK] button.

[Level]

- The user level is set up in 3 steps. You can set different setup and search authorizations in each step to enable various users to manage the DVR system systematically.

[Setup]

- You can set up the authorization for each user level fully or partially in terms of system setup.
- Check [System] to run several functions such as User Management, Site Information, Software Upgrade, Log Information, OSD/Dwell Time, System Management, and System Shutdown.
- Check [Record] to run functions such as Recording, Motion Detection, Schedule, and Quality/Resolution.
- Check [Camera] to run functions such as Channel Setting, Sensor Setting, Sensor/Control Link, Sensor/Camera Link, and Spot Out/Camera Link.
- Check [Network] to run functions such as Network Setup and Emergency Notification.
- Check [Backup] to set up the backup schedule for Local/Remote Backup.

[Search]

- Check [Playback] to enable search.
- Check [Backup] to set up the JPG/BMP, KDB, and AVI backup and remote backup for any image saved.

7.3.2 Site Information

[Figure 7-11. Site Information]

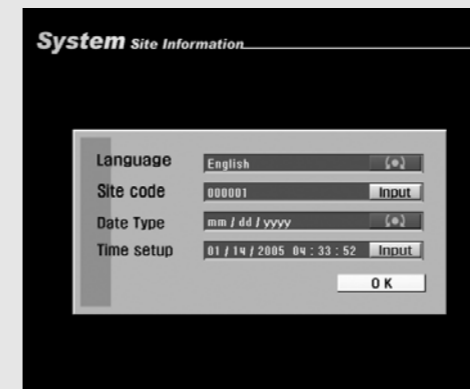

[Figure 7-12. Site Information setup]

- In [Site Information], you can change the [Site Code], [Date Type], and [Time Setup] options.

[Language]

- Select the language you wish to use.

[Site Code]

- You can assign an ID code to the system to make it recognizable when multiple systems are connected through network.

[Date Type]

- You can change the date display format.

[Time Setup]

- You can change the date and time

[Note]

- This system is equipped with high performance crystal clock and might have 20 ppm of time difference. Therefore, it might have a little bit of time difference from the international standard time. Please make sure to check correctness of the time. For detailed time adjustment, refer to the manual.

[Site Code]

- You can assign an ID code to the system to make it recognizable when multiple systems are connected through network.
- The Site Code comprises 6 digits. When entering Site Code, you can enter a maximum of 6 digits. Default is "000001"
- Use the mouse or the directional keys to type in the Site Code. Once you select [OK] button, the new Site Code will apply immediately.

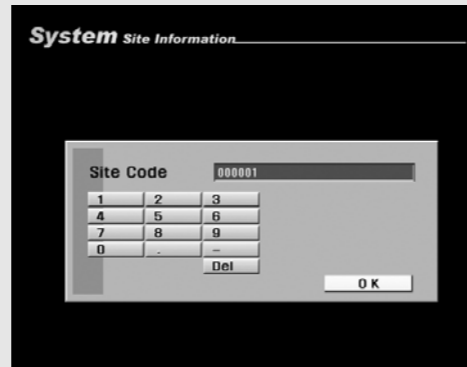

[Figure 7-13. Side Code setup]

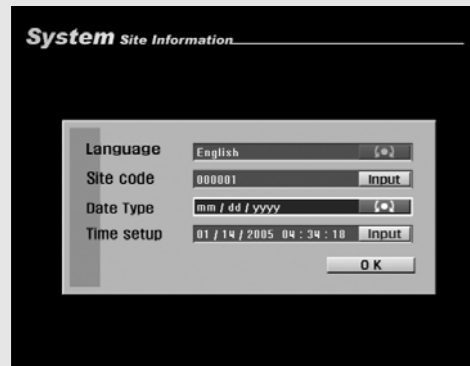

[Figure 7-14. Date Type setup]

[Date Type]

- You can change the date display format.
- Available date format is listed below:
yyyy/mm/dd, yyyy-mm-dd, yyyy.mm.dd
mm/dd/yyyy, mm-dd-yyyy, mm.dd.yyyy
dd/mm/yyyy, dd-mm-yyyy, dd.mm.yyyy

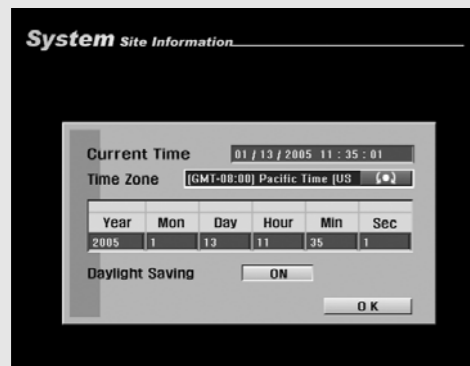

[Figure 7-15. Date/Time setup]

[Time Setup]

- You can change the date and time.
- Check the time zone of your region, then use the mouse wheel or the jog/shuttle to set the **[Time Zone]**.
- To change year/month/day and time, use the mouse or the directional keys on the system to highlight the option you wish to change, then use the mouse wheel or the jog/shuttle to change the option. If Daylight Saving applies in your region, select the **[Daylight Saving]** option.
- The NTP feature is supported only in the Time Zone in the Setup menu.

7.3.3 Software Upgrade

[Figure 7-16. Software Upgrade]



[Figure 7-17. Software Upgrade menu]

- In **[Software Upgrade]** menu, you can update your system program to new software versions when they become available.

[Package Select]

- You can upgrade the system program by using a portable storage device to be recognized by DVR. The upgrade package must be in a folder called "upgrade". Connect the storage device containing an upgrade package to the USB port, then press **[Select]**. The system will display the number of packages found.

[Upgraded Version]

- After a portable storage device is connected, you can select the **[Upgrade Version]** using the mouse wheel or the jog/shuttle on the system.

[Current Version]

- You can view the current system program version.
- Check to make sure the upgrade package version is better than the current version, then select **[Start]** to begin the upgrade.

⚠ [Caution]

- When upgrading is in progress, do not switch off the system or unplug the portable storage device containing the upgrade package until the upgrade is complete. Otherwise, the system may malfunction.

7.3.4 Log Information



[Figure 7-18. Log Information]

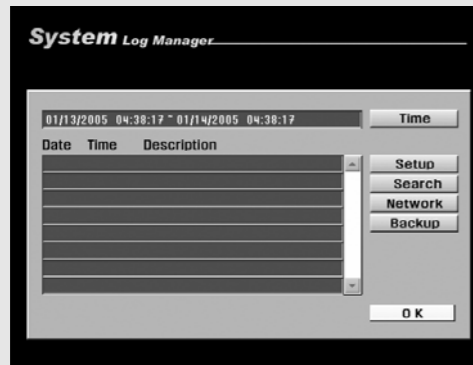

[Figure 7-19. Log Information]

- In [Log Information] menu, you can view the log information on Setup history, Search history, network connection history, and backup history.

[Time]

- Displays selected date and time.

[Setup]

- Displays log information on any changes made to Setup menu.

[Search]

- Displays log information on Search history.

[Network]

- Displays log information on network connection history.

[Backup]

- Displays log information on backup history.

[OK]

- Select [OK] button to return to Setup menu.



[Figure 7-20. Selecting Time]



[Figure 7-21. Log Information – Setup history]

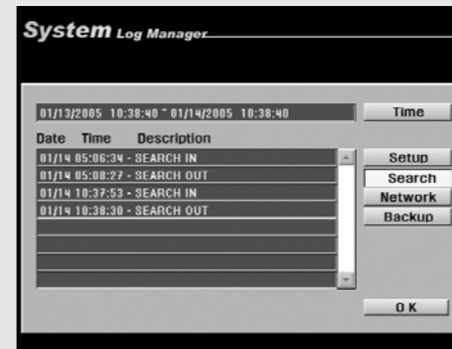

[Figure 7-22. Log Information – Search history]

[Time]

- Select [Time] to change time to view log information recorded on different date/time.
- Change [Start Time] and [End Time] using the mouse and mouse wheel or the directional keys and the jog/shuttle, then press [OK] button. The system will display the log information recorded during this period.

[Setup]

- The system records the date and time whenever the Setup mode was accessed and changed.
- Select [Setup] button to view the log information on Setup mode history. You will see “SETUP START” when Setup mode was accessed and “SETUP END” when Setup mode was exited.

[Search]

- The system records the date and time whenever Search mode was accessed for viewing the recording.
- Select [Search] button to view the log information on Search mode history. You will see “SEARCH IN” when Search mode was accessed and “SEARCH OUT” when Search mode was exited.

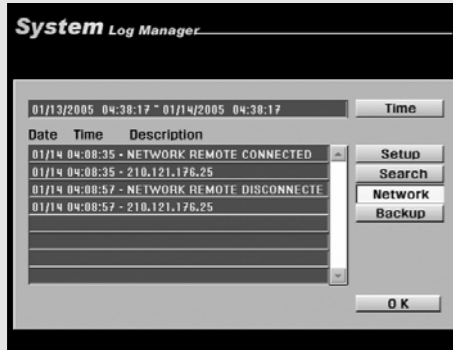

[Figure 7-23. Log Information – Network connection history]

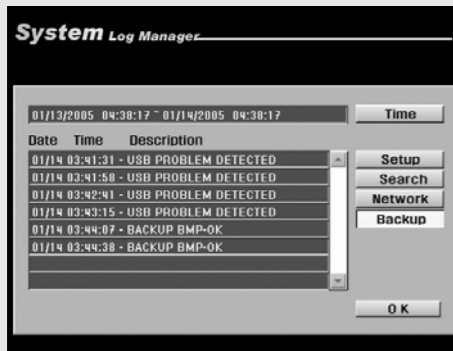

[Figure 7-24. Log Information – Backup history]

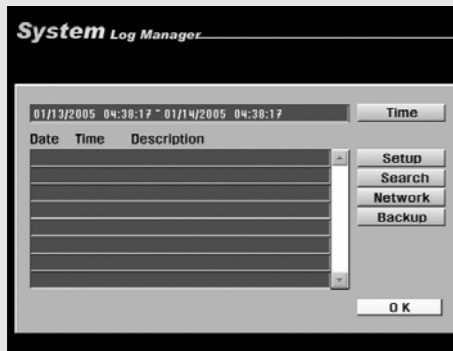

[Figure 7-25. Exiting Log Information menu]

[Network]

- Whenever the system is connected through network by remote Center program, the system will record the IP address and the date and time the connection is made.

[Backup]

- Whenever the system saves a backup, it records the date, time, and the location of the backup saved.

[OK]

- Select [OK] button to return to Setup menu.

7.3.5 OSD/Dwell Time

[Figure 7-26. OSD/Dwell Time]

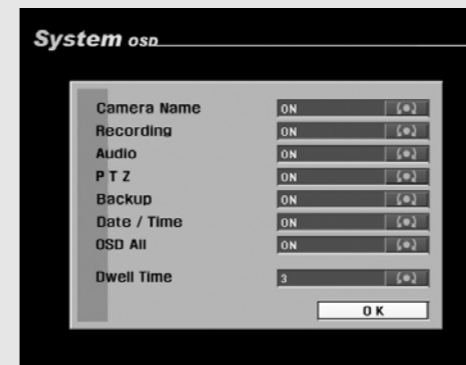

[Figure 7-27. OSD/Dwell Time setup]

- You can change the options on OSD-On Screen Display-and sequence time function.
- You can turn the display settings in Surveillance mode on or off, such as [Camera Name], [Recording], [Audio], [P/T/Z], and [Date/Time] displays.
- Select [OSD All] to turn all screen displays on or off.
- You can set the channel sequence time from 1 second to 60 seconds by changing the value of [Dwell Time] by using the mouse wheel or the jog/shuttle.

7.3.6 System Management

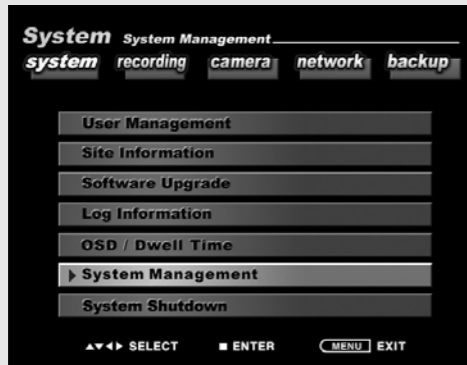

[Figure 7-28. System management]

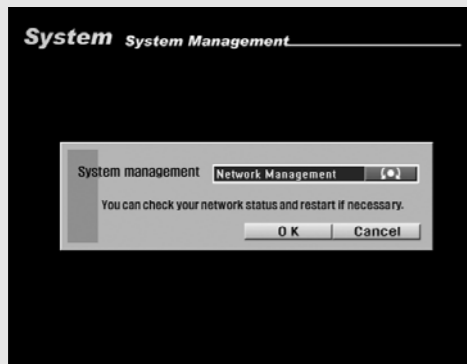

[Figure 7-29. Selecting Network Management]

- Use the [Manage System] menu to check the network status, authenticate the Dynamic DNS (DDNS), adjust the audio volume, and set the video input type, system ID, and external HDD format.

- You can select the field to be set using the mouse scroll wheel or Jog/Shuttle.
- After selecting a field, press the [OK] button.

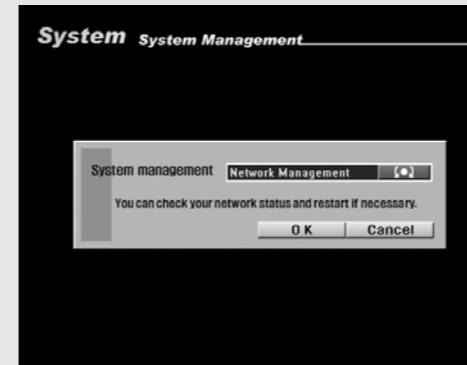

[Figure 7-30. Selecting Network Management]

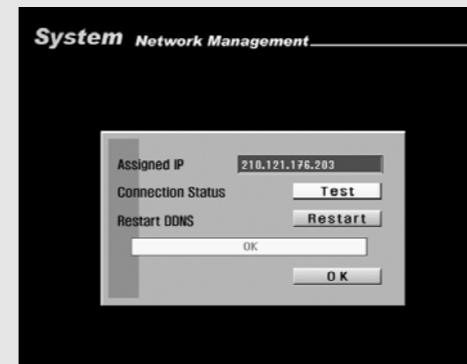

[Figure 7-31. Network Management]

- Select “Network Management” to check the network status or to restart DDNS authentication and click the [OK] button.

[Assigned IP]

- Assigned IP displays the system’s IP address used for remote backup and remote monitoring.

[Connection Status]

- Connection Status indicates whether the current assigned IP address can be used to connect to the Internet. If it is possible, the system will display “OK” in the progress bar. Otherwise, the system will display “Failed”.

[DDNS Restart]

- Receive a new DDNS authentication
- DDNS authentication allows you to use Internet using the IP address (ADSL, DHCP).

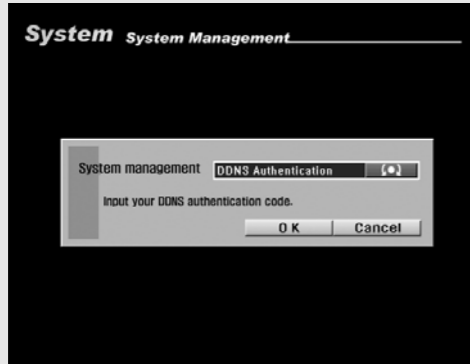

[Figure 7-32. Selecting DDNS Authentication]



[Figure 7-33. DDNS Authentication]

- To use the DDNS service, select “DDNS Authentication” and click the [OK] button.

[Authentication Number]

- Enter the DDNS authentication number.

[ID]

- Enter DDNS ID.

[Password]

- Enter DDNS password.

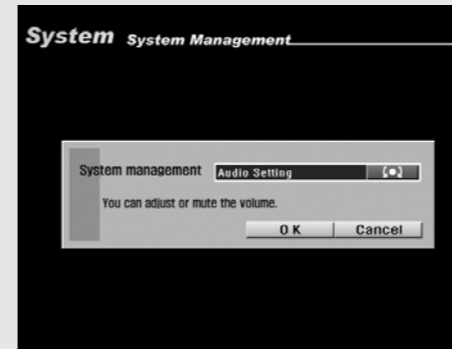

[Figure 7-34. Selecting Audio Setting]

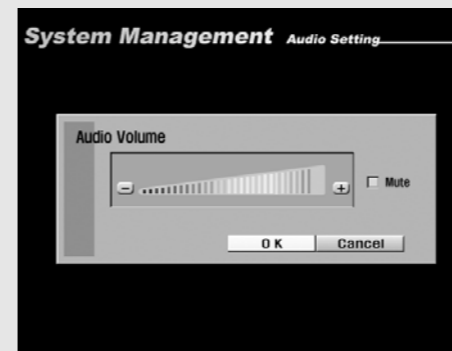

[Figure 7-35. Audio Volume]

- Select “Audio Setting ” to adjust the system audio volume or to mute the sound and click the [OK] button.

[Audio Volume]

- Click the [-] or [+] buttons to adjust the audio volumes.
- Select the [Mute] button to mute the sound.

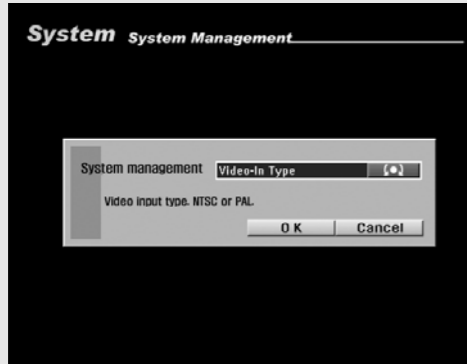

[Figure 7-36. Selecting Video-In Type]

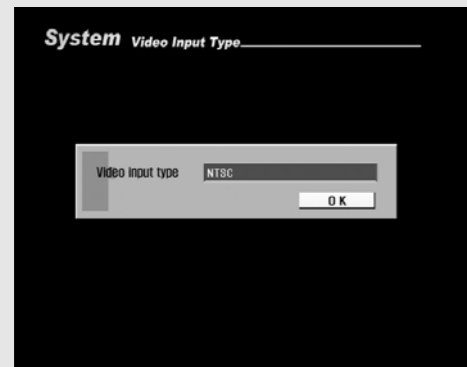

[Figure 7-37. Video In Type]

- Select the video-in type to check the type of image input and click the [OK] button.

[Video Type]

- Select the video input type of the image source.

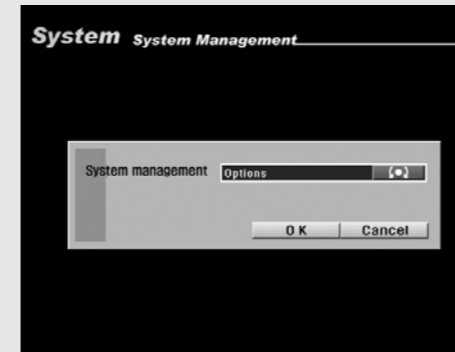

[Figure 7-38. Selecting Options]

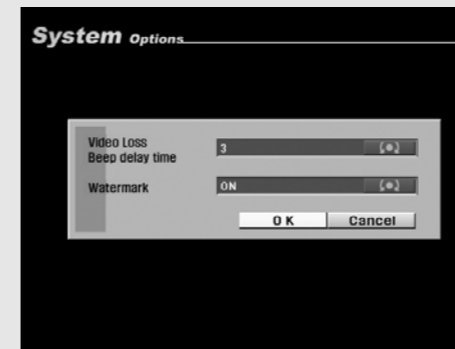

[Figure 7-39. Video Beep delay time and Watermark]

- Select "Options" to set a warning beep in case of video loss or to set the watermark in video data and click the [OK] button.

[Video Loss Beep delay time]

- Sounds the beep and sets its delay time in case of video loss.

[watermark]

- Select ON/OFF to enable/disable the Watermark option in the video data.

[Note] Watermark?

- Watermark inserts within video data a mark that is invisible to the human eye, it can only be recognized by kodium. The "Watermark program" lets you detect any counterfeit video data.

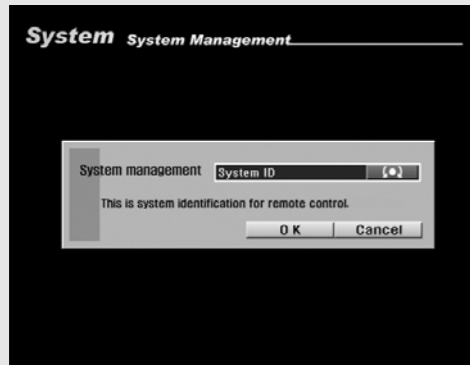

[Figure 7-40. Selecting System ID]

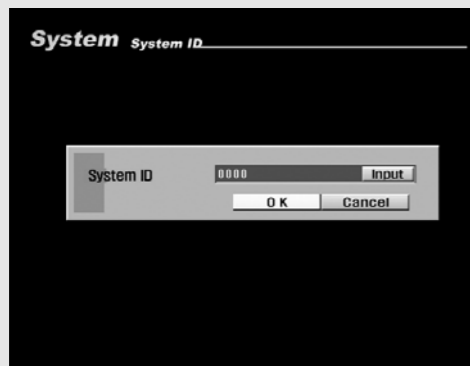

[Figure 7-41. Sustum ID]

- To set a unique system ID for communication between the DVR and remote controller, select "System ID" and click the [OK] button.

[System ID]

- Click the [Input] button to set a unique system ID.

[Note]

- By default, the system ID of the DVR is set to "1". With the system ID set to "1", you can control the DVR without adjusting the remote controller.
- Setting the system IDs of several DVRs to "1" lets you control all of them at once.
- If the system ID is 1~16, press the [System ID] button on the remote controller and select the system ID that you want to control remotely.

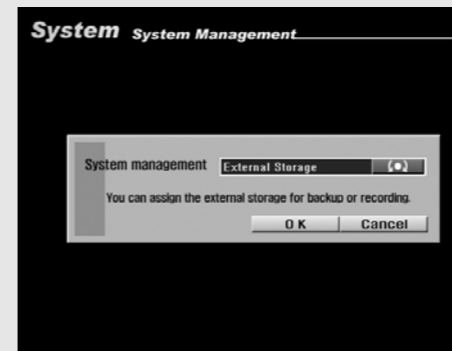

[Figure 7-42. Selecting External Storage]

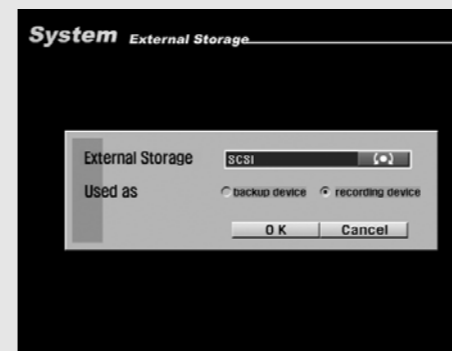

[Figure 7-43. Defining the Function of the External Storage]

- To set the function of the external storage to be connected to the DVR, i.e, backup device or recording backup, select "External Storage" and click the [OK] button.

[External Storage]

- Select the port to which the external storage is connected. (SCSI or IEEE1394)

[Used as]

- External storage can serve as a backup device or the recording backup.
- Select "Backup Device" to use the external storage as a backup device, and "Recording device" as the recording device, and click the [OK] button.

**[Note]**

- Do not disconnect the cable or turn off external storage during operation.
(may cause the DVR system to malfunction or damage the file system of the external storage). In case of damage to the file system of the external storage, or recover the file system using a recovery program.)

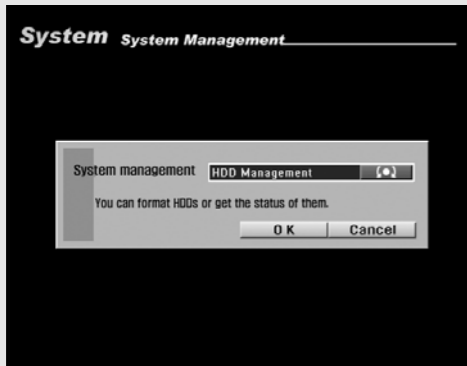

[Figure 7-44. Selecting HDD Management]



[Figure 7-45. HDD table]

- To renew the HDD installed in the system, select “HDD Management” and click the [OK] button.

- The table shows the system’s built-in HDDs and their information. You can install up to HDD into the system.
- From the table, you can select the HDD you wish to format, then select [OK] button. The system will display a confirmation message shown in Figure 7-46

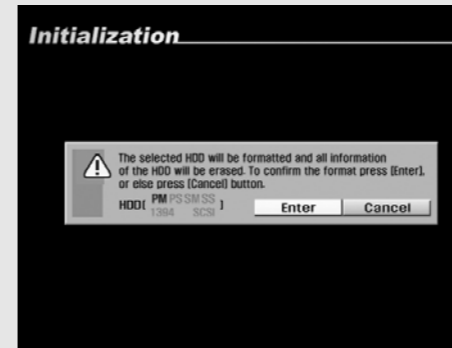

[Figure 7-46. Confirmation message]



[Figure 7-47. HDD format progress]

- The system will display a warning message. To confirm and proceed with formatting the selected HDD, press [OK] button. To cancel format and return to HDD table, select [Cancel] button.

- You can view the HDD format progress through the progress bar.
- The system will restart once the format is complete.

[Caution]

- Any newly installed HDD must be formatted.
- Formatting will erase all data stored in the selected HDD. Please make sure you have saved all important data before proceeding with HDD format (see page 27 for details on saving backup).

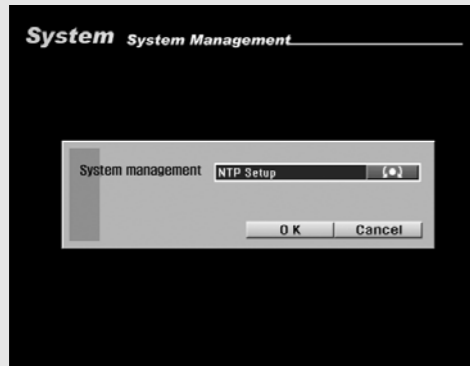

[Figure 7-48. Selecting NTP Setup]

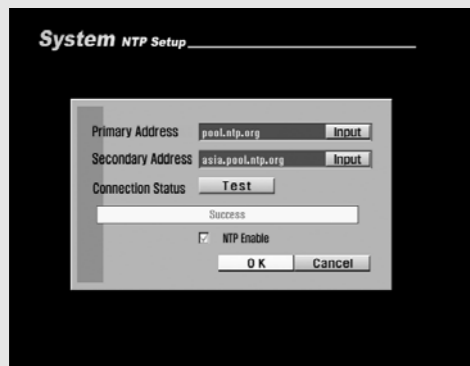

[Figure 7-49. NTP Setup]

- To receive the international standard time data from the NTP(Network Time Protocol) server and to synchronize the system, select “NTP Setup” and click on [OK] button.

[Primary Address] and [Secondary Address]

- To input the NTP Server address, click on [Input] button and type in the address of the NTP server.

[Connection Status]

- To check the connection status with the NTP server in [Primary Address] or [Secondary Address] field, click on [Test] button.
- When communication is possible with the NTP server, “Success” is displayed on the progress bar. Otherwise, “Fail” is displayed.

[NTP Enable]

- The operator can decide whether to use NTP feature or not. To use the NTP feature, click on [NTP Enable] button.

[Note]

- The operator cannot change the time in the Setup menu but can only set the Time Zone while the NTP feature is enabled.
- The NTP server and the system are synchronized every hour.

* NTP Server list

ISO	Area	NTP Server Address
	Worldwide	pool.ntp.org
	Asia	asia.pool.ntp.org
	Europe	europa.pool.ntp.org
	North America	north-america.pool.ntp.org
	Oceania	oceania.pool.ntp.org
	South America	south-america.pool.ntp.org
AT	Austria	at.pool.ntp.org
AU	Australia	au.pool.ntp.org
BE	Belgium	be.pool.ntp.org
CA	Canada	ca.pool.ntp.org
CH	Switzerland	ch.pool.ntp.org
CL	Chile	cl.pool.ntp.org
DE	Germany	de.pool.ntp.org
DK	Denmark	dk.pool.ntp.org
ES	Spain	es.pool.ntp.org
FI	Finland	fi.pool.ntp.org
FR	France	fr.pool.ntp.org
GT	Guatemala	gt.pool.ntp.org
IE	Ireland	ie.pool.ntp.org
IT	Italy	it.pool.ntp.org
JP	Japan	jp.pool.ntp.org
MX	Mexico	mx.pool.ntp.org
MY	Malaysia	my.pool.ntp.org
NL	Netherlands	nl.pool.ntp.org
NO	Norway	no.pool.ntp.org
NZ	New Zealand	nz.pool.ntp.org
PH	Philippines	ph.pool.ntp.org
PL	Poland	pl.pool.ntp.org
PT	Portugal	pt.pool.ntp.org
RU	Russia	ru.pool.ntp.org
SE	Sweden	se.pool.ntp.org
US	USA	us.pool.ntp.org

7.3.7 System Shutdown

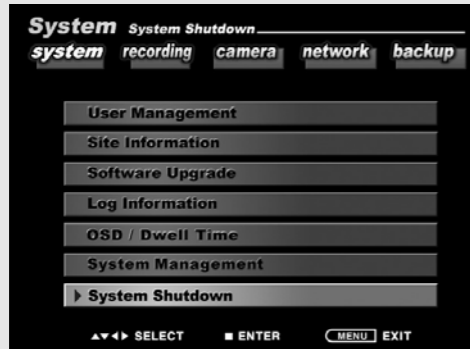

[Figure 7-50. System Shutdown]

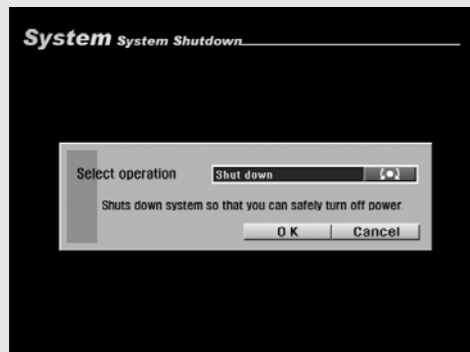

[Figure 7-51. System Shutdown menu]

- In [System Shutdown] menu, you can safely shutdown, restart or schedule a reboot of the system.
- Use mouse wheel or the jog/shuttle to select [Shutdown], [Restart], or [Add Schedule], then press [OK] button.

[Shut down]

- Shut down the system.

[Restart]

- Restart the system.

[Add schedule]

- Add automatic reboot schedule .

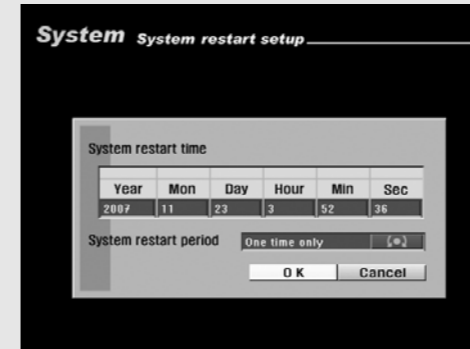

[Figure 7-52. System restart schedule]

[Add schedule]

- You can set the time and the system will automatically restart.
- Use the mouse wheel or the jog/shuttle to select [System Restart Period]. You can assign the system to automatically restart [One time only], [Daily], [Every 2 days], [Every 3 days], [Weekly], [Every 2 weeks], [Every 3 weeks], or [Monthly].
- Restarting the system on regular basis may help to stabilize the system performance.

7.4 Recording Setup

7.4.1 Recording Setup

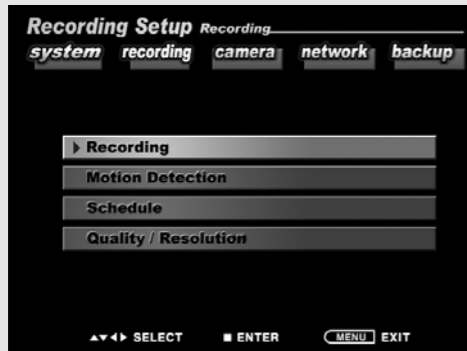

[Figure 7-53. Recording setup]

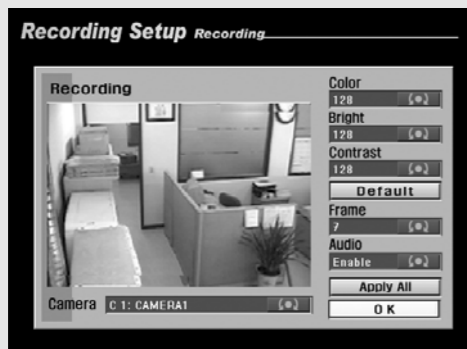

[Figure 7-54. Recording setup]

[Note]

- Recording frame rate may vary depending on the number of installed cameras or system load.

- In [Recording] setup menu, you can change the color, brightness, contrast, and the frame rate for each cameras as well as setting audio recording.

[Color/Brightness/Contrast]

- You can set the color, brightness, and contrast of the selected camera.
- Use the mouse wheel or the jog/shuttle to set the value of each option between 0~255.

[Default]

- Select [Default] button to set the color, brightness, and contrast to their default value.

[Frame]

- You can set the recording frame rate between 1~30 fps(25fps in PAL) for each camera using the jog/shuttle dial on the system.

[Audio]

- To record sound with the selected camera, switch the [Audio] option to "ON" using the jog/shuttle on the system.
- Select whether to save audio data or not for each camera.

[Apply All]

- Click the [Apply All] button to apply the current camera setting to all cameras.

[Camera]

- Use the jog/shuttle on the system to select other cameras for set up.

7.4.2 Motion Detection

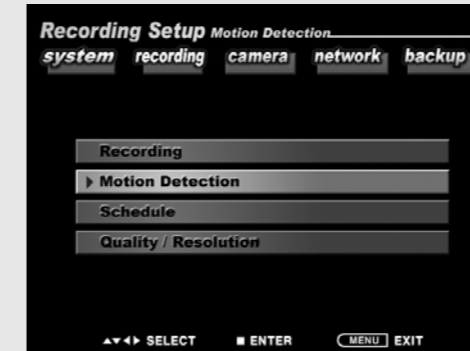

[Figure 7-55. Motion Detection]

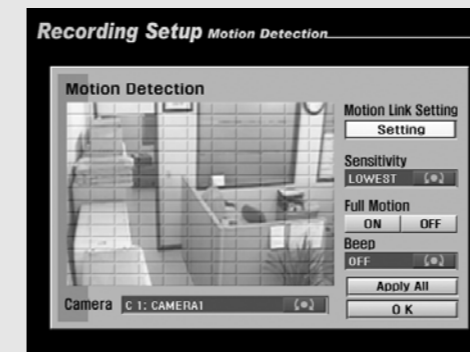

[Figure 7-56. Motion-detection setting]

- In [Motion Detection] menu, you can set motion detection area, set motion sensitivity, and enable or disable alert sound(beeping).

[Setting Motion Detection]

- To set Motion Detection area, highlight a block of the area of the channel screen by using the directional keys, then press Enter key to select the block.
- The channel screen is divided into 165 blocks. You can select as many blocks as you wish up to 165.

[Sensitivity]

- You can set the motion-detection sensitivity of each camera to "LOWEST", "LOW", "NORMAL", "HIGH", or "HIGHEST".

[Full Motion]

- To set the whole channel screen to motion-detection area, switch the [Full Motion] option to "ON". To cancel the whole screen from motion-detection area, switch the option to "OFF".

[Beep]

- To hear a 'beep' warning sound when the system detects movement in motion-detection area, set the [Beep] option to "ON". To hear no warning sound, set the option to "OFF".

[Camera]

- Use the jog/shuttle on the system to select other cameras for set up.

[Apply All]

- Click the [Apply All] button to apply the current camera setting to all cameras.

[OK]

- Press [OK] button to accept any changes made and return to Setup menu

7.4.3 Motion Link Setting

[Motion link setting]

- You can set a motion-link recording for each camera.
- When the camera detects movement in the motion-detection area, the linked camera will begin recording as well, regardless of its recording schedule.
- To use Motion-link recording, the camera detecting the movement must be set to Motion-Detection recording in the schedule. If the camera's schedule is set to Continuous Recording, Motion Link will be disabled.
- In Surveillance mode, when the camera detects movement in its motion-detection area, the linked camera channel will flash 'REC' and begin recording.

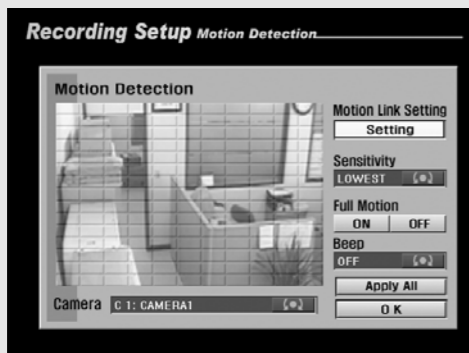

[Figure 7-57. Motion Link setting]

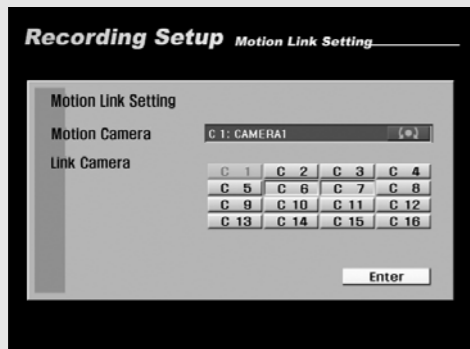

[Figure 7-58. Motion Connection Setup Screen]

- To access Motion Link setting, use the mouse or the directional keys to select [Setting]. The system will display Motion link setup as shown in Figure 7-58.

[Motion Camera]

- Select the camera that will detect the movement in its motion-detection area by using the mouse wheel or the jog/shuttle on the system.

[Link Camera]

- Select the cameras that will be linked to the [Motion Camera] by using the mouse or the directional keys. You can link multiple cameras to the [Motion Camera].

7.4.4 Schedule



[Figure 7-59. Schedule]

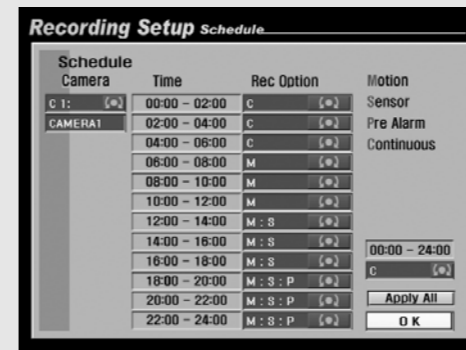

[Figure 7-60. Schedule Setup]

- In [Schedule] menu, you can set automatic schedule for each camera and their recording mode.

[Camera]

- Use the mouse wheel or the jog/shuttle to select the camera to change its schedule.

[Recording Mode]

- You can select a recording mode for the selected camera by using the mouse or the direction keys to highlight the time you wish to set, then use the mouse wheel or the jog/shuttle to change the recording mode.
- Available recording modes are listed on the table below. You can also set non-recording period per camera if you wish to.

[Apply All]

- Click the [Apply All] button to apply the current camera setting to all cameras.

Recording Mode	Available Recording Modes	Schedule Setup Display	Channel Display
<ul style="list-style-type: none"> • C : Continuous Recording • M : Motion Recording • S : Sensor Recording • P : Pre-alarm Recording 	• No Recording	NONE	None
	• Continuous Recording	C	Red 'R'
	• Motion Recording	M	Orange 'R'
	• Sensor Recording	S	
	• Motion & Sensor Recording	M : S	
	• Motion & Pre-alarm Recording	M : P	
	• Sensor & Pre-alarm Recording	S : P	Black 'R'
	• Motion & Sensor & Pre-alarm Recording	M : S : P	
• Instant Recording	-		

[Table 7-2. Recording modes]

7.4.5 Quality/Resolution



[Figure 7-61. Quality/Resolution]



[Figure 7-62. Quality/Resolution setup]

- In [Quality/Resolution] menu, you can change the video quality and resolution by using the mouse wheel or the jog/shuttle.
- Any changes made to quality and resolution will apply to all cameras.

[Quality]

- You can change the video quality to “LOWEST”, “LOW”, “NORMAL”, “HIGH”, and “BEST”.

[Resolution]

- You can change the video resolution to 352 X 240 or 704 X 240, 704 X 480 (PAL : 384 X 288, 704 X 288, 704 X 576)

[OK]

- Select [OK] button to accept any changes made and return to Setup menu.

7.5 Camera Setup

- In [Camera] setup menu, you can setup Pan/Tilt mode and change the connection setting between sensors and controls.

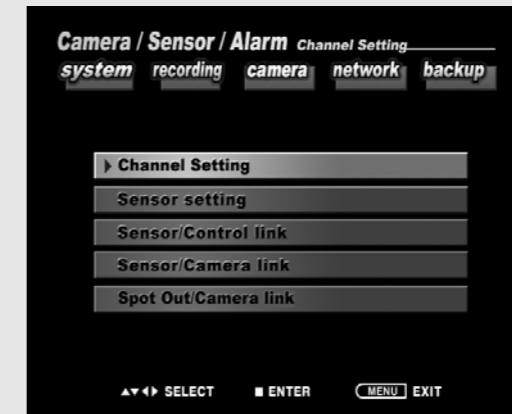

[Figure 7-63. Camera Setup menu]

[Channel Setting]

- Lets you select the use and name of the camera and PTZ model.

[Sensor setting]

- You can change the settings for each sensor (see page 69 for details).

[Sensor/Control Link]

- You can link the control devices to a sensor (see page 70 for details).

[Sensor/Camera Link]

- You can link the sensor to activate camera(s) (see page 71 for details).

[Spot Out/Camera link]

- You can select the camera that will be displayed on the Spot monitor (see page 72 for details).

7.5.1 Channel Setting



[Figure 7-64. Channel Setting]

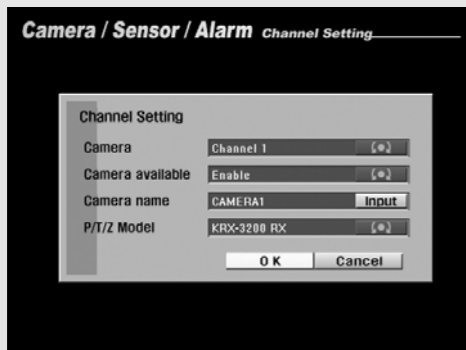

[Figure 7-65. Channel Setup Screen]

- [Channel Setting] select the use and name of the camera or PTZ model of the selected camera channel.

[Camera]

- Lets you change the camera channel using the mouse scroll wheel or jog/shuttle.

[Camera available]

- Set the use of the selected camera using the mouse scroll wheel or jog/shuttle.

[Camera Name]

- Click the [Input] button to set the name of the selected camera. The camera name may consist of up to ten alphanumeric characters.

[P/T/Z model]

- Lets you select P/T/Z on the selected camera channel.
- You can select the Speed Dome or RX-Receiver using the mouse scroll wheel or jog/shuttle.

7.5.2 Sensor setting

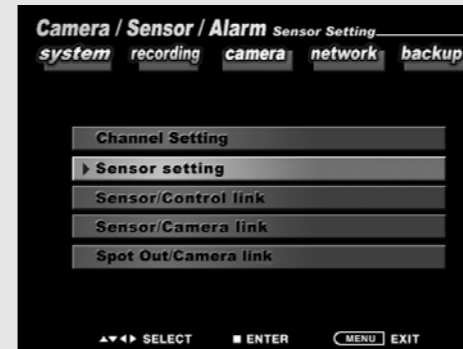

[Figure 7-66. Sensor setting]

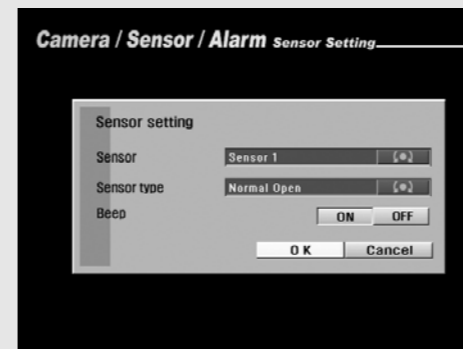

[Figure 7-67. Sensor setting]

- In [Sensor setting] menu, you can select a sensor type for any of 16 connected sensors, and enable or disable alarm sound.

[Sensor]

- Use the mouse wheel or the jog/shuttle to select a sensor.

[Sensor Type]

- Use the mouse wheel or the jog/shuttle to select “Normally Open” or “Normally Close” sensor types.
- Normally Close type = If the door/object with the sensor installed is not closed, the sensor will trigger.
- Normally Open type = If the door/object with the sensor installed is not opened, the sensor will trigger.

[Beep]

- When sensors are triggered, the system will produce “beep” alarm sound through its internal speakers. Select “ON” to enable alarm, and select “OFF” to disable it.

7.5.3 Sensor/Control link



[Figure 7-68. Sensor/Control link]

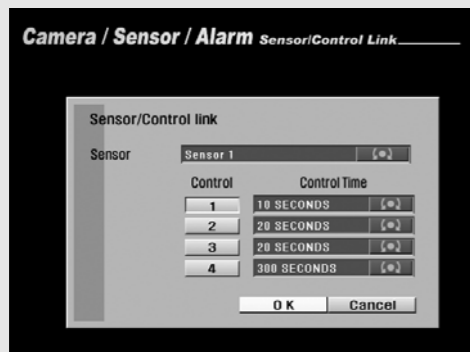

[Figure 7-69. Sensor/Control link setup]

- In [Sensor/Control link] menu, you can link a sensor with controls and set control time.

[Sensor]

- Use the mouse wheel or the jog/shuttle to select a sensor.

[Control]

- You can link a sensor with control devices. When a sensor is triggered, the linked control device(s) will automatically activate.

[Control Time]

- You can set how long the control devices will stay activated. The value can be changed in 10 seconds segments up to maximum of 300 seconds.
- Use the mouse wheel or the jog/shuttle to change [Control Time].

7.5.4 Sensor/Camera Link



[Figure 7-70. Sensor/Camera Link]

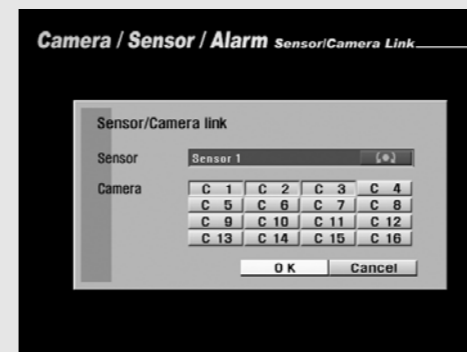

[Figure 7-71. Sensor/camera link setup]

- In [Sensor/Camera Link] menu, you can link cameras to Sensors.

[Sensor]

- Select the sensor you wish to link by using the mouse wheel or the jog/shuttle.

[Camera]

- Select the cameras you wish to link with the selected sensor by using the mouse or the directional keys and Enter key.
- When the sensor is triggered, its linked camera(s) will automatically begin recording.

[Note]

- To have the cameras automatically record when a sensor is triggered, the schedule for the linked cameras must be set to "S", "S:P", "M:S", or "M:S:P" (see page 61 for details on schedule setup).

7.5.5 Spot Out/Camera link



[Figure 7-72. Spot/Camera link]

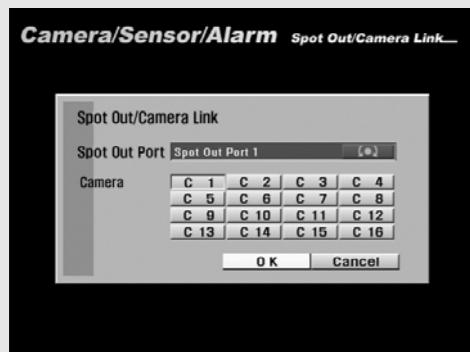

[Figure 7-73. Spot/Camera link setup]

- **[Spot Out/Camera link]** Lets you select the camera that will be shown on the Spot monitor.

[Spot Out Port]

- Lets you select the interworking Spot monitor together with the selected camera.

[Camera]

- Select the camera that interworks with the Spot monitor.
- For Spots 1~5, you can select on camera for each monitor.

7.6 Network Setup

- Set the network for communication with the center program using the [Network setup] menu. To notify the administrator in a remote location of any emergency through E-mail, set the emergency warning function.

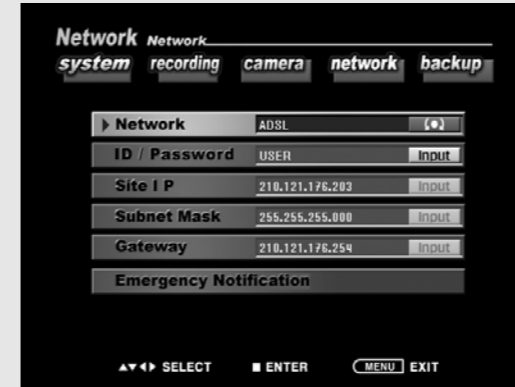

[Figure 7-74. Network Setup Screen]

[Subnet Mask]

- You can enter the system's subnet mask in order to communication with the Center program when connected through LAN.

[Gateway]

- You can enter the system's gateway address in order to communication with the Center using LAN.

[Emergency Notification]

- In case of an emergency, emergency images are immediately sent to a remote location or through e-mail.
- To send emergency images to a remote location, set the network address where the center program is installed.
- To send emergency images to the administrator's mail address, set the SMTP mail server address, sender's mail address, and recipient's mail address.

[Network]

- The system supports network connection through LAN using IP address, as well as DHCP, ADSL, and modem. (Modem set up not available in Europe)
- Select the network option you wish to use by mouse or the jog/shuttle.
- LAN is the standard network connection for DVR.

[ID/PASSWORD]

- Logging in ADSL require ID / PASSWORD.

[Site IP]

- Enter the system's IP address for connecting DVR to a remote Center via LAN (see page 74 for details.)

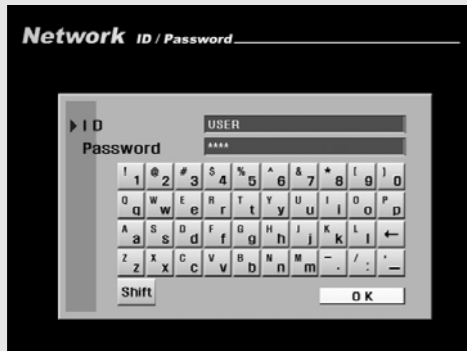

[Figure 7-75. ID/Password setup]

[ID/Password setup]

- When using ADSL or VDSL network, you must enter the ID and password of remote back up server.
- Use the mouse or the directional keys and **Enter** key to enter the ID and password.

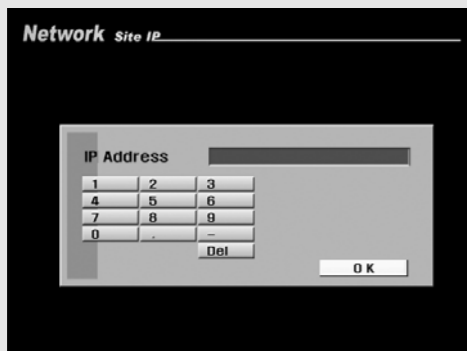

[Figure 7-76. IP Address setup]

[IP address setup]

- Screen for inputting **[Site IP]**, **[Subnet Mask]**, and **[Gateway]**.
- Use the mouse or the directional keys and **Enter** key to enter the IP address.

- When sensor signals are generated during an emergency, corresponding images are sent to the remote location where the center program is installed using the Emergency Notification feature. To use the Emergency Notification function, set the network address of the center, transmission time, and interworking event.

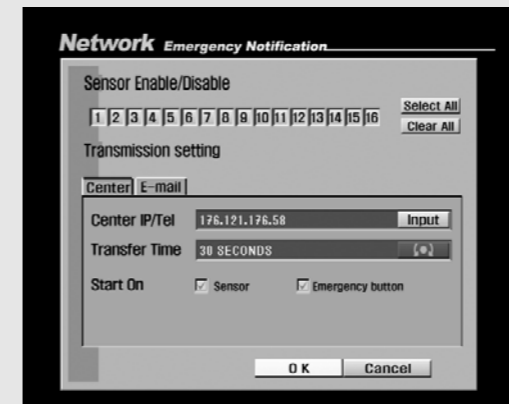

[Figure 7-77. Center Setup]

- center program is installed, click the **[Input]** button.
- To connect to a remote location by modem, input the telephone number of the remote location.

[Transmission Time]

- Set the time for transmitting images to a remote location.
- You can change the transmitting time using the mouse scroll wheel or Jog/Shuttle.

[Interworking Event]

- To enable the Emergency Notification feature by sensor event, select the **[Sensor]** Event field.
- To enable the Emergency Notification feature using the **[Emergency]** button on the front panel of the system, select the **[Emergency Button]** Event field.

[Select/Unselect Sensor]

- You can select/unselect the sensor to be used as an emergency sensor.
- In case a signal is generated in the emergency sensor, the images of the camera connected to it are transmitted to a remote location.

[Center] Tab

- To set the center connection environment, click the **[Center]** tab.

[E-mail] Tab

- To set the E-mail environment, click **[E-mail]** tab.

[Center IP/Tel]

- To input the network IP address where the

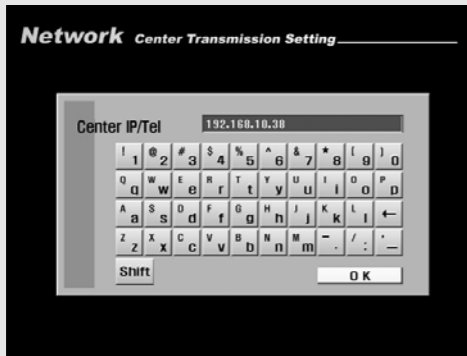

[Figure 7-78. Center IP/Tel Setup]

[Center IP/Tel Input Screen]

- Input the IP address or telephone number of the center using the mouse or directional keys and press the Enter button on the front panel of the system.

- To receive emergency notices via E-mail, set the SMTP address, sender's mail address, recipient's mail address.

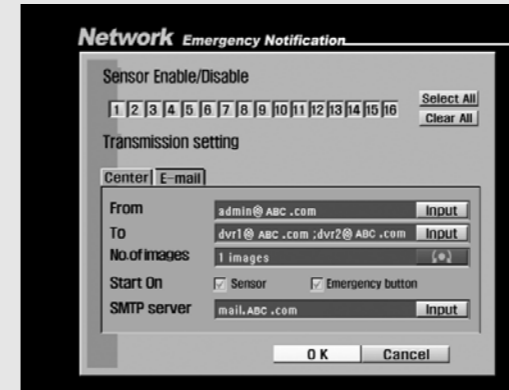

[Figure 7-79. E-mail Setup]

[From]

- To input the mail sender's account, click the [Input] button.

[To]

- To input the recipient's mail address in case of an emergency, click the [Input] button.

[No. of images]

- Set the number of images that can be transmitted to a mail address.
- In case the image count is set to "None" only messages without images are transmitted.

[interworking Event]

- To enable the Emergency Notification feature by sensor event, select the [Sensor] Event field.
- To enable the Emergency Notification feature using the [Emergency] button on the front panel of the system, select the [Emergency Button] Event field.

[SMTP Mail Server]

- Input the address of the mail-sending server.
- To set the SMTP mail server, click the [Input] button.

[Select/Unselect Sensor]

- You can select/unselect the sensor to be used as an emergency sensor.
- In case a signal is generated in the emergency sensor, the images of the camera connected to it are transmitted to a remote location.
- You can easily select/unselect all sensors using the [Select All] and [Clear All] buttons.

[Center] Tab

- To set the center connection environment, click the [Center] tab.

[E-mail] Tab

- To set the E-mail environment, click [E-mail] tab.

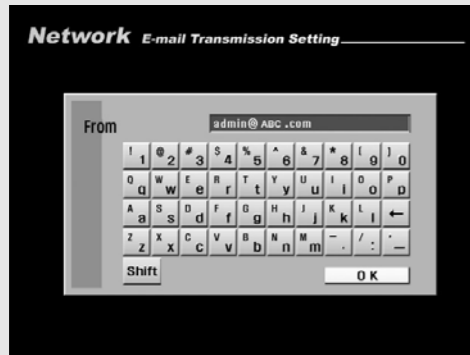

[Figure 7-80. Center Transmission Setup]

[Input Sender's Mail Address]

- Input the mail sender's address using the mouse or directional keys and press the Enter button on the front panel of the system.

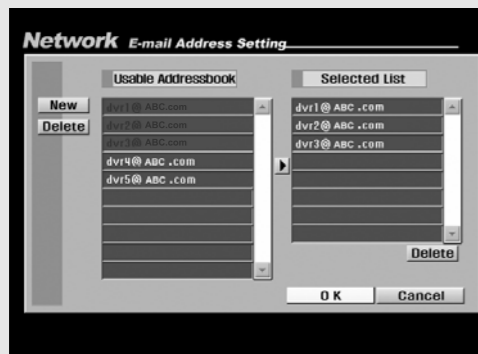

[Figure 7-81. Recipient E-mail Address Setup]

[Recipient Mail Setup]

- You can input the recipient's mail address in case of an emergency. To add a new mail address to the e-mail address list, click the **[Add]** button. To delete an address from the list, click the **[Delete]** button.
- To add an e-mail address to the recipients list, select the mail address from the e-mail addresses list and click the **[▶]** button.

[Note]

- Input the correct e-mail address including the @ symbol..

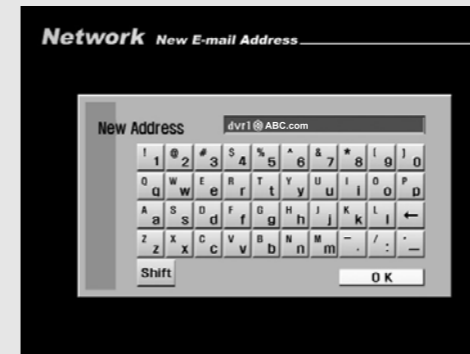

[Figure 7-82. Adding New Mail]

[Input a New Mail Address]

- Input a new mail address.
- Input a new mail address using the mouse or directional keys and press the Enter button on the front panel of the system.



[Figure 7-83. SMTP Mail Server Setup]

[SMTP Mail Server Information Input Screen]

- Input The SMTP server information for the composed mail.

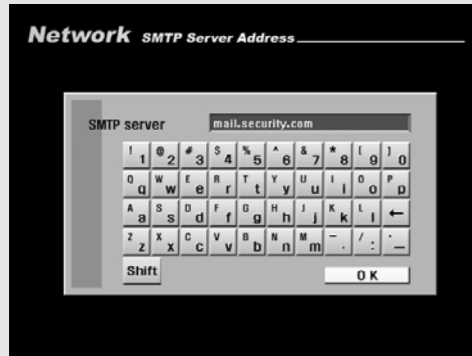

[Figure 7-84. SMTP Address Input]

[SMTP Mail Server Address Input Screen]

- Input the SMTP mail server address for the composed mail using the mouse or directional keys and press the Enter button on the front panel of the system.

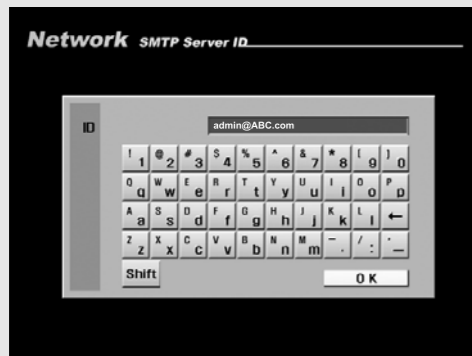

[Figure 7-85. SMTP Mail Server Account Input]

[SMTP Mail Server Account Input Screen]

- Input the mail account of the SMTP server.

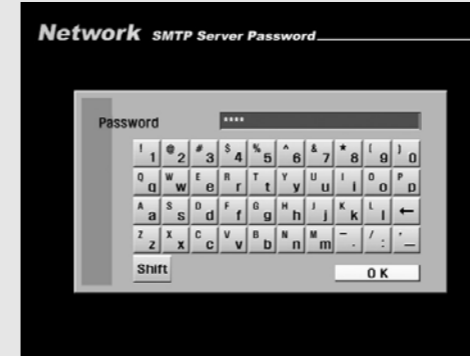

[Figure 7-86. SMTP Password Input]

[SMTP Mail Server Password Input Screen]

- Input the mail account password of the SMTP server.

7.7 Backup Schedule



[Figure 7-87 Backup Schedule]

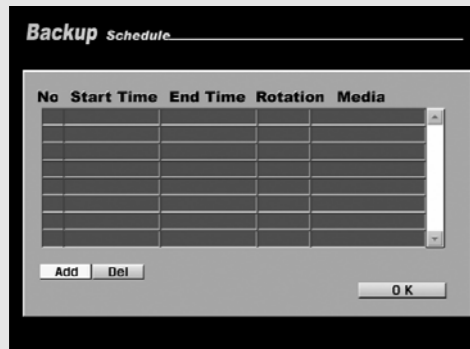

[Figure 7-88. Backup schedule setup]

- In [Backup Schedule] menu, you can set up a system backup schedule so that the system will automatically save backup copies of specific recordings.

- Backup Schedule programs the system to save a backup copy of the recorded data to a designated storage device set by the schedule.
- You can only schedule the system to save a backup copy of the recording that will be recorded in the future. You cannot schedule the system to save a backup that has been recorded before the current date. To do this, you must access the Search mode.

7.7.1 Adding Backup schedule

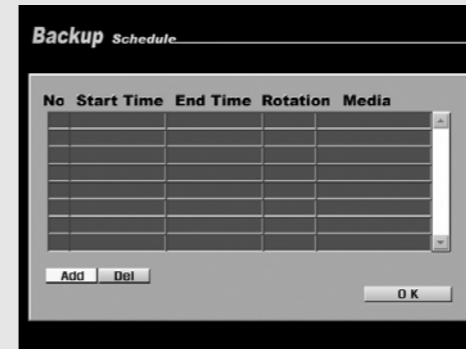

[Figure 7-89. Adding backup schedule]



[Figure 7-90. Adding backup schedule]

- To add a backup schedule to the list, select [Add] button.

- To add a backup schedule, you must set the [Start Time] and [End Time], [Target Drive], and [Rotate] options.



[Figure 7-91. Start Time setup]

[Start Time / End Time]

- To select **[Start Time]** and **[End Time]**, use the mouse or the directional keys to select the time and date, then use the mouse wheel or the shuttle to select the time period of the recording you wish to save.
- Select **[OK]** button to apply the selected times.

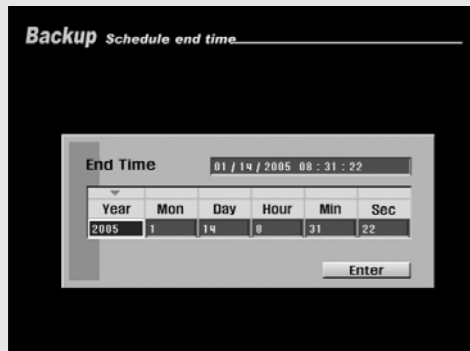

[Figure 7-92. End Time]

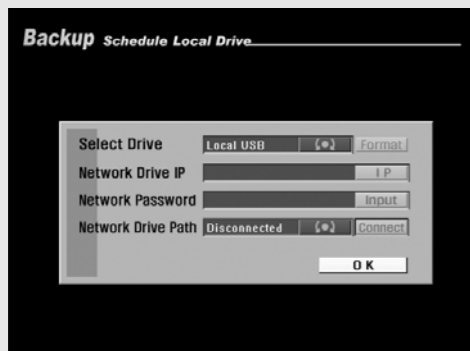

[Figure 7-93. Selecting Target Drive]

[Target Drive]

- Select the target drive that will be used for saving the backup of the recording
- You can select remote Drive or local USB for backup.

[Note]

- Archiving images onto CD-RW is supported only in playback mode.

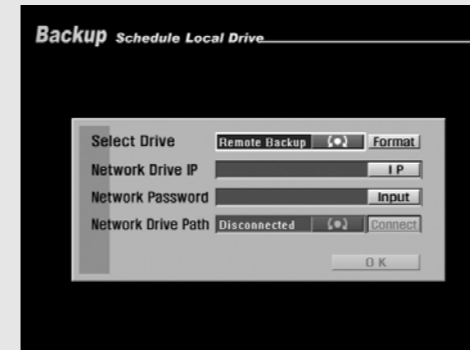

[Figure 7-94. Remote Drive setup]

[Target Drive - Remote Drive]

- Use the mouse wheel or the jog/shuttle to select Remote Drive.
- If the system is connected through LAN or Internet line, you can save a remote drive backup by entering the correct IP address.
- When saving a remote drive backup, the receiving PC or fileserver must have the Center Program installed with Backup Server Program running.
- To save a remote drive backup, you will need the IP address and the password of the receiving PC or fileserver.
- To enter IP address and password, use the directional keys to highlight **[Input]** button, then press Enter.

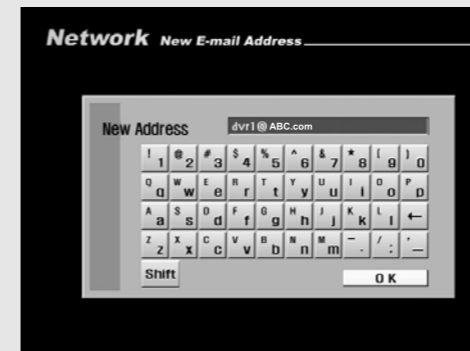

[Figure 7-95. Remote Drive IP Address]

[Saving Point - Remote Drive IP]

- To set the **[Remote Drive]**, enter the IP address of the remote place that is connected to the network where the center program and the remote backup server are installed.
- Enter the IP address of the remote site by pressing direction keys and Enter key on the front part of the system

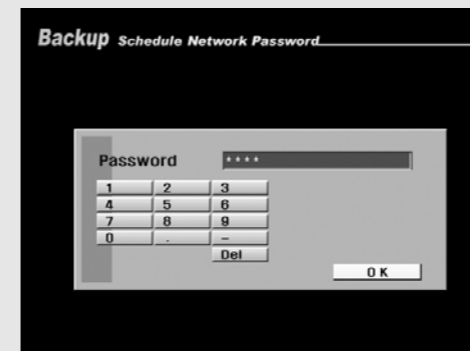

[Figure 7-96. Remote Drive Password]

[Network Drive IP] and [Network Password]

- To enter the Network Drive IP address and Network password, use the mouse or the directional keys and Enter button to select the numbers and letters. Press **[OK]** button to apply the selected IP address and password.

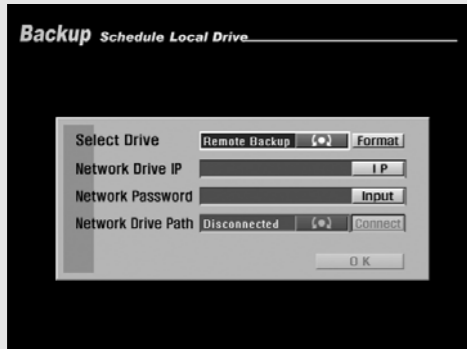

[Figure 7-97. Remote Drive setup]



[Figure 7-98. Remote Drive Setup]

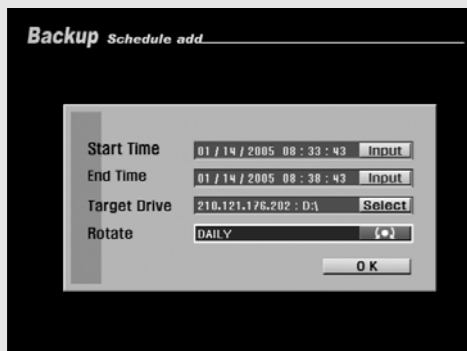

[Figure 7-99. Remote Drive setup]

[Connecting]

- Press the **[Connect]** button to connect the system to the receiving PC or fileserver in order to save a remote drive backup. Once connected, you will be able to select Network Drive path.
- Depending on the connection status, the system will display either “Connect”, “Disconnect”, or “Connect fail” message.

[OK]

- Once you have entered the **[Network Drive IP]**, **[Network Password]**, and **[Network Drive Path]**, select **[OK]** button to return to Backup Schedule list.

[Rotate]

- You can schedule the system to save a backup of the selected time in daily, weekly, monthly, or yearly basis. To do so, use the mouse wheel or the jog/shuttle to select a rotation cycle.

[OK]

- Once you have selected the **[Start Time]**, **[End Time]**, **[Target Drive]**, and **[Rotate]**, press **[OK]** button to add it to backup schedule list.

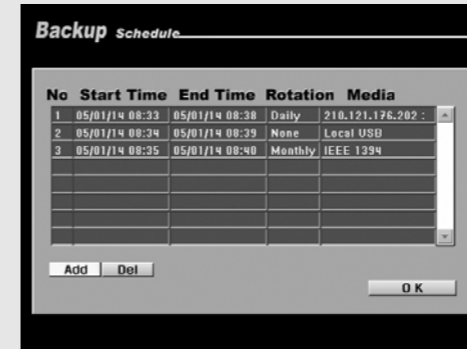

[Figure 7-100. Backup Schedule list]

[Backup Schedule List]

- You will see the added schedule on the Backup Schedule list. Select **[OK]** button to accept the schedule and return to Setup menu.

8. Controls – Manual Control

8.1 Switching to Control Mode

If you wish to use the control devices manually, select the 16-split screen mode in Surveillance mode, then press Enter key. You will then be able to select the control devices you wish to use manually.



[Figure 8-1. 16-splitscreen mode]

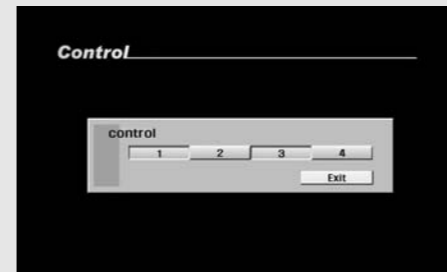

[Figure 8-2. Control Screen]

[Control]

- Use the mouse or the directional keys and **Enter** key to select the control device numbers you wish to control manually.

[Exiting Control mode]

- Press **[OK]** button to return to Surveillance mode.

7.7.2 Deleting Backup Schedule

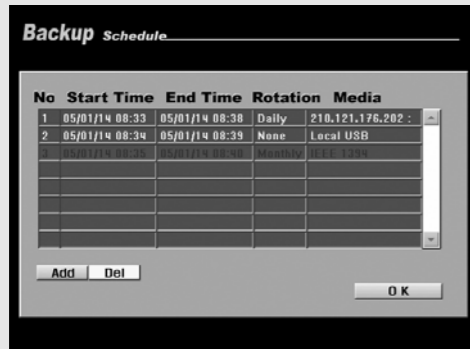

[Figure 7-101. Deleting backup schedule]

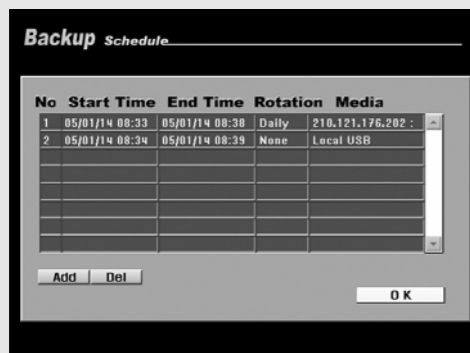

[Figure 7-102. Deleting backup schedule]

- To delete a schedule from the list, select the schedule you wish to delete by using the directional keys and **Enter** key. Then select **[Del]** button to delete the schedule.

- Select **[OK]** button to accept the schedule and return to Setup menu.

2. Installation

1. Pan/Tilt Connection
2. Connecting LAN/PSTN Communication Lines
3. RX Receiver (KRE-303) Connection Diagram (optional)
4. External Sensor Connection (Input)
5. Control Port Connection (Output)
6. Adding HDD
7. HDD Smart Check
8. External Storage Setup
9. Formatting External Storage

1. Pan/Tilt Connection



RS-485 Signal Cable Connection Port
(Used for connecting RX-Receiver)

[Caution]

- Please beware of (+ve) and (-ve) poles of the signal cable when connecting. A Wrong connection may cause malfunction to the system.
- If you wish to use an RX-receiver, please contact your dealer beforehand.

2. Connecting LAN/PSTN Communication Lines

2.1 LAN and Dedicated Line Connection

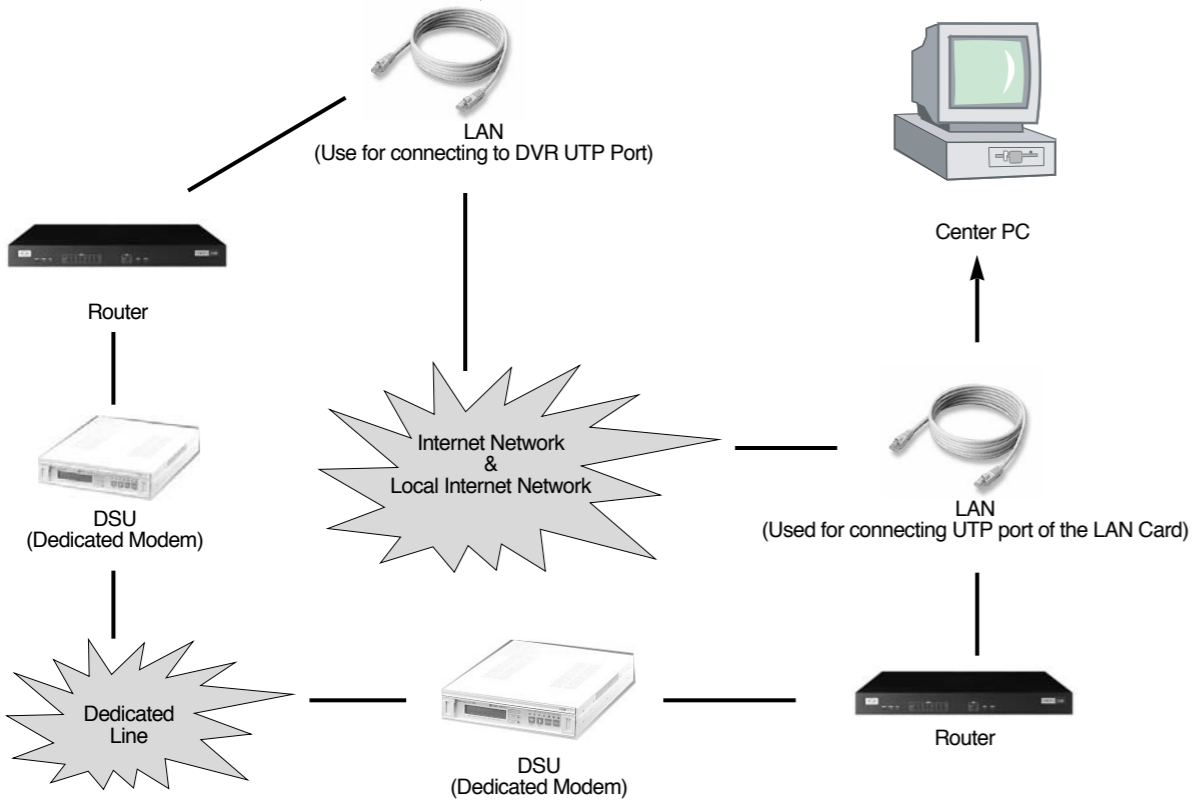

LAN/PSTN Communication

2.2 PSTN (telephone line) Connection (options) (Not available Europe)

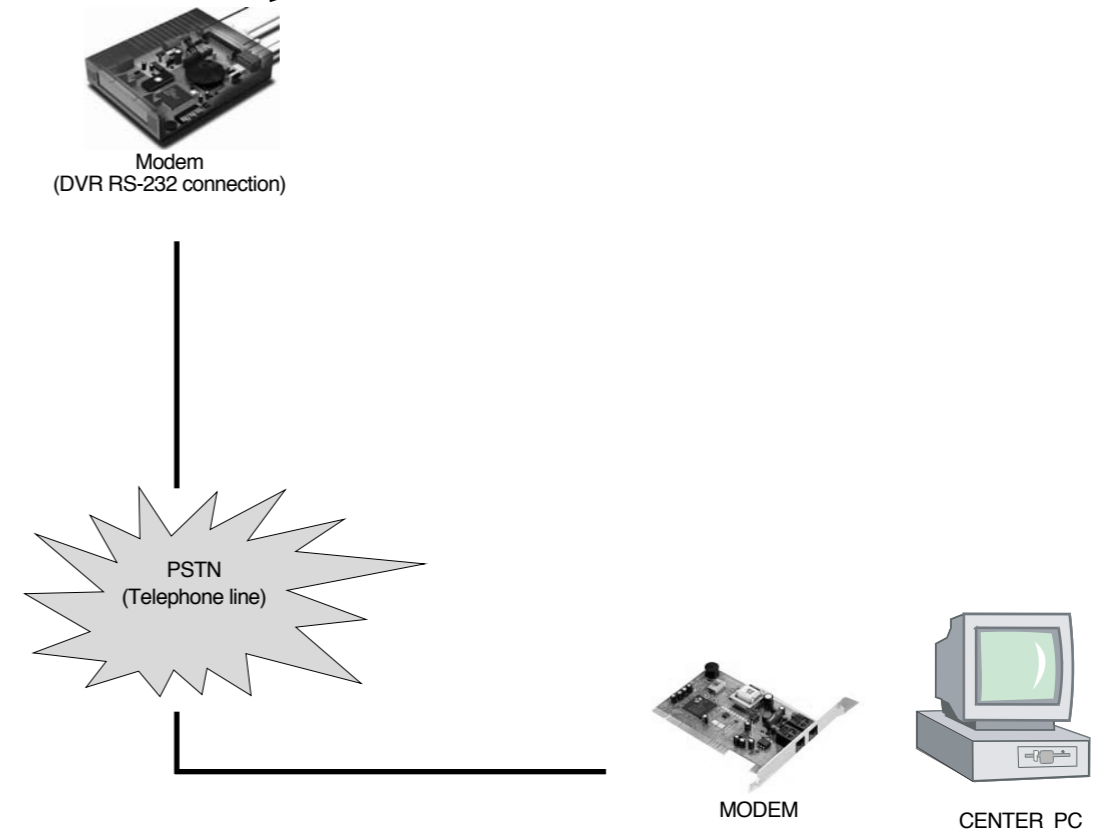

LAN/PSTN Communication

3. RX Receiver (KRE-303) Connection Diagram (optional)

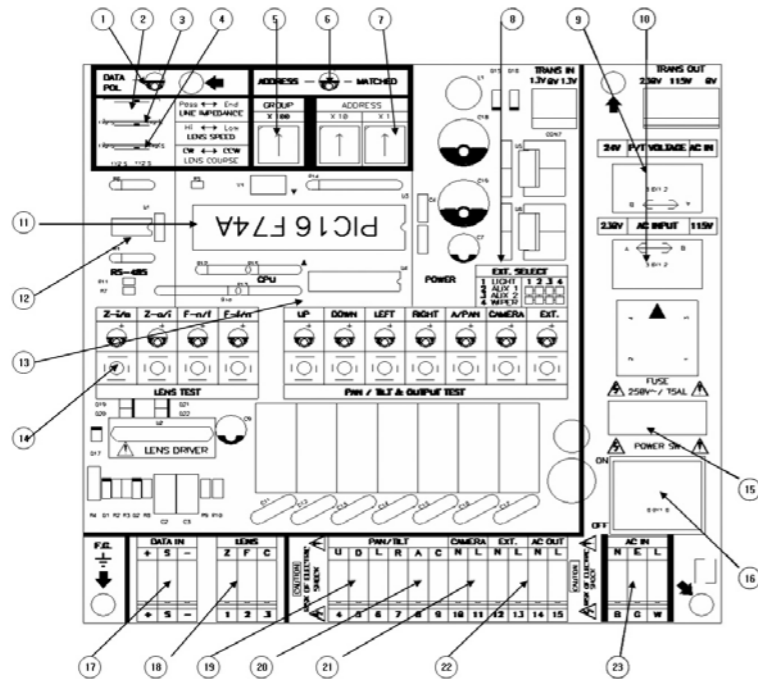

[Caution]
 The voltage of the light controlling output port is the same as the AC input voltage. The operating voltage of the camera lens is fixed to DC 12V.

3.1 Part Name and Description

1. Turns "ON" when polarity of data lines connected correctly.
2. Used for ON-OFF of the cross resistance according to the international standard, EIA-485.
3. DC±6V when it is LOW, DC ±12V when it is HIGH.
4. Used for reversing the polarity of ZOOM/FOCUS control output.
5. Used along side with MATRIX CARD, else it is "0"
6. Turns "ON" when summoned camera number from DVR or TX match.
7. Created from the left in order of "100/10/1"
8. Output of EXT is adjustable from DVR depending on the condition at site.
9. P/T control voltage output is classified into AC24V and input voltage. The default is AC24V.
10. Input voltage selection switch for AC 110V/220V. The default is AC220V.
11. High end commercial usage only, PIC 16F74
12. Can be replaced with National N75176-Japan or Maxim MAX485 IC-USA.
13. Used to check the condition of PAN/TILT and ON-OFF output.
14. Used to check the condition of MOTORIZED ZOOM LENS output.
15. Input power is 250V/10A when AC 110V is selected, and is 250V/5A when AC220V is selected.
16. Main power switch capable of ON-OFF on 2 lines at the same time.
17. Data input terminal capable of receiving RS-485EIA signal; be cautious of polarity.
18. 3 lines per output, in order of ZOOM(1)/FOCUS(2)/COMMON(3)
19. Arranged in order of UP/DOWN/LEFT/RIGHT/AUTO PAN/COMMON (4,5,6,7,8,9 consecutive)
20. Power output related to camera and its housing; AC voltage output.
21. LIGHT / AUX 1,2 / AUDIO - Maximum of 1KW of AC voltage output
22. AC power source used for installation/repair, usable by connecting to wall outlet.
23. Used in main power input terminal of AC 110V, or alternate power of 220V.

4. External Sensor Connection (Input)

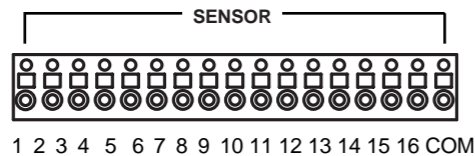

Connect one of the two signal lines from the sensor (infrared sensor, magnetic) to COM port, and connect the other signal line to the desired sensor number. (Set the sensor "NC, NO" type in "Set Camera" menu See Page 69 for details on Sensor type setting)



[Caution]

Use a separate adapter to supply power to each sensor.

5. Control Port Connection (Output)

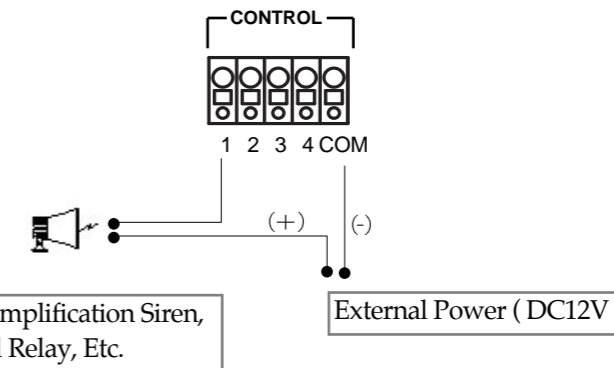

Alarm Light, Amplification Siren, External Relay, Etc.

External Power (DC12V)

- During automatic control of an external sensor, the control output port is "interworked" (the value set in "Set Camera" menu) and "COM" port is connected.
- In normal occasions, the control output is kept in "NO" status.
- When control is triggered, the control output changes to "NC" status.

[Caution]

- The operating voltage should be maximum 12V, 300mA.
- When controlling lights and other devices operated by AC power, use a separate external relay.

External Sensor Connection

Control Port Connection

6. Adding HDD

6.1 Installing new HDD

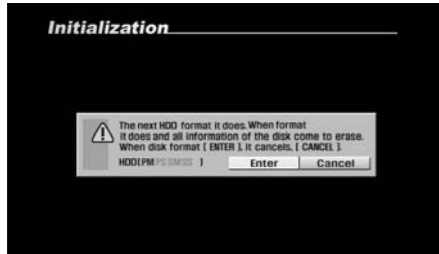

[Figure 6-1. HDD Format]

- Turn the system off and install the new HDD into the system.
- Turn the system back on and wait for the HDD format message.
- The message will ask you to confirm HDD format. HDD format is a necessary procedure before using the newly installed HDD.
- Press **[Yes]** button to being formatting the new HDD. Pressing **[No]** button will cancel HDD format and shutdown the system.

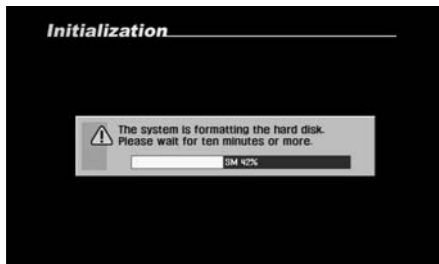

[Figure 6-2. HDD Format progress]

- Once the system begins formatting the HDD, you can view the progress through the progress bar.
- Once HDD is complete, the system will restart.



[Caution]

- You are recommended to check both the original HDD and the new Hdd Interface jumper and set the MASTER and SLAVE.
- Any newly installed HDD **must** be formatted
- Remember that formatting will erase any data stored on the new HDD. Please make sure you have saved any important data before proceeding with HDD format.

6.2 Checking HDD Database

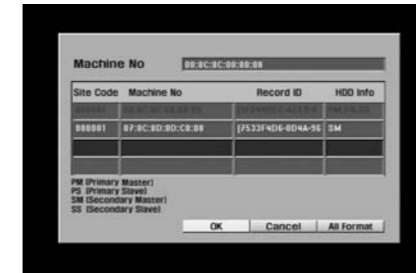

[Figure 6-3. HDD Table]

- If the newly installed HDD database does not correspond with the original HDD, the system will display the HDD table.
- If the database of the HDDs do not correspond, you must format either the system's original HDD or the newly installed HDD.
- From the table, you can select the HDD you wish to format, then select **[OK]** button. The system will display a confirmation message shown in Figure 6-4.
- Select **[Cancel]** button to exit HDD table screen.

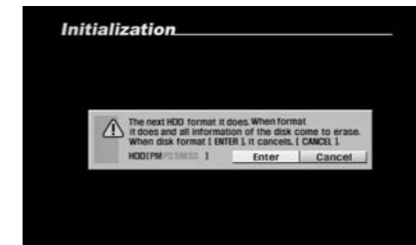

[Figure 6-4. HDD confirm message]

[All Format]

- Press **[All Format]** button to format all existing HDDs.
- The system will display a warning message. To confirm and proceed with formatting the selected HDD, press **[OK]** button. To cancel format and return to HDD table, select **[Cancel]** button.



[Figure 6-5. HDD Format progress]

- You can view the HDD format progress through the progress bar.
- The system will restart once the format is complete.



[Caution]

- Any newly installed HDD must be formatted
- Remember that formatting will erase all data stored on the selected HDD. Please make sure you have saved all important data before proceeding with HDD format (see page 27 for details on saving backup).

7. HDD Smart Check



7.1 HDD Smart Check

This is a function to notify the user possibilities of HDD crash in advance. This, by advance warning, is to protect the HDD from losing data or crashing that may come from bad sector or overheating.



[Figure 7-1. Main surveillance screen]

① [HDD warning icon]

- When the installed HDD has a problem such as bad sector or overheated DVR will beep or this icon  will appear.
- It is strongly recommended to replace HDD when the HDD warning icon  appears or beeps.
- The beep will appear every 10 seconds.

[Caution]

- HDD smart check function works only when the HDD in use supports S.M.A.R.T
- Check whether the HDD installed supports S.M.A.R.T.
- Avoid using old HDD or low capacity HDD.

8. External Storage Setup

With the system power turned off, connect external storage (SCSI, IEEE1394) before turning on the power button. Upon booting you system, you will see the “External Storage” set up screen featuring as installed external storage device. Users may select the external storage as the backup or recording.

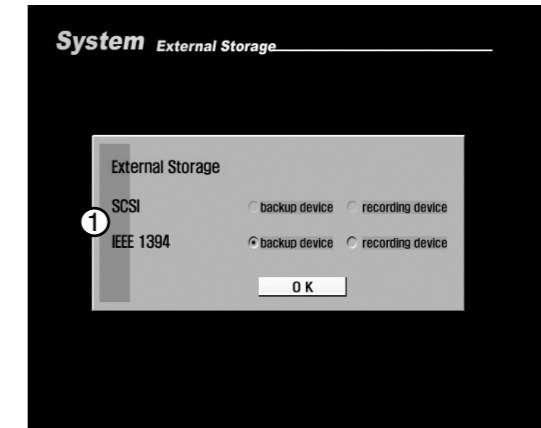

[Figure 8-1. External Storage screen]

① [SCSI] and [IEEE1394]

- To use external storage (SCSI, IEEE1394) either as backup or recording, select “backup device” or “recording device” respectively, and click the [OK] button.

[Caution]

- You can define the SCSI ID between 0 and 15 (except 7).

9. Formatting External Storage

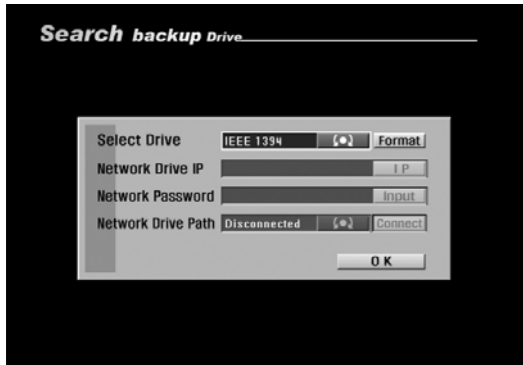

[Figure 9-1. Select External Storage]

- To use external storage (IEEE1394, SCSI) as backup device, select "Local SCSI" or "IEEE1394" and click [Format].

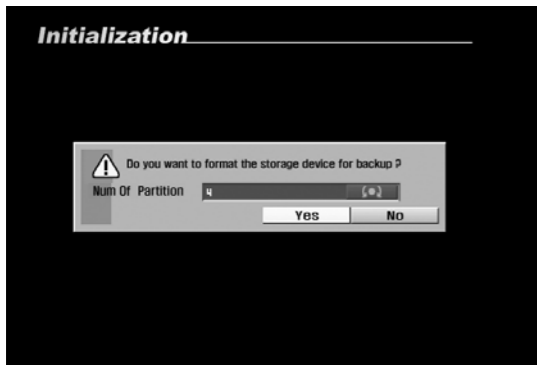

[Figure 9-2. Set Partitions in the External Storage]

- Before formatting the external storage, set the number of partitions. (The numbers of partitions does not depend on the capacity of the storage; for optimal access rate between the system and storage, however, set the number of partitions by referring to the table on the next page [Number of Partitions by HDD Capacity]).
- Click [Yes] to format the storage. Otherwise, the [NO] to go back to the previous screen.

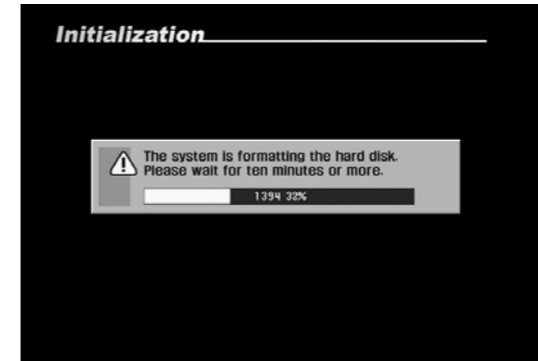

[Figure 9-3. Format External Storage]

- A bar showing the formatting progress is displayed.
- After formatting is complete, the [Select External Storage] screen is then displayed.

NO	HDD Capacity	Partitions
1	32GB ~ 128GB	4
2	128GB ~ 160GB	5
3	160GB ~ 192GB	6
4	192GB ~ 224GB	7
5	224GB ~ 800GB	8

[Table 9-1. Number of Partitions by HDD Capacity]

3. Appendix

1. Viewer
2. WebDVR
3. Specification
4. FAQ
5. Product warranty

1. Viewer

1.1 How to run Viewer

- ① When you insert the CD containing KDB data in CD-RW, it will start by autorun. If you do not have autorun on your PC, you can access the viewer file by double clicking the Viewer folder.

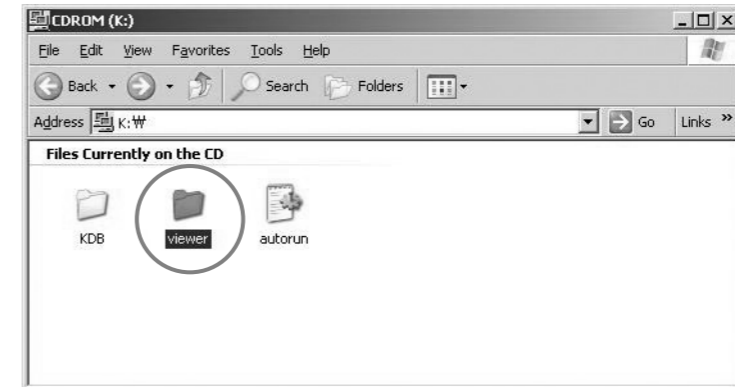

- ② The Viewer will work when you double-click "Viewer.exe"

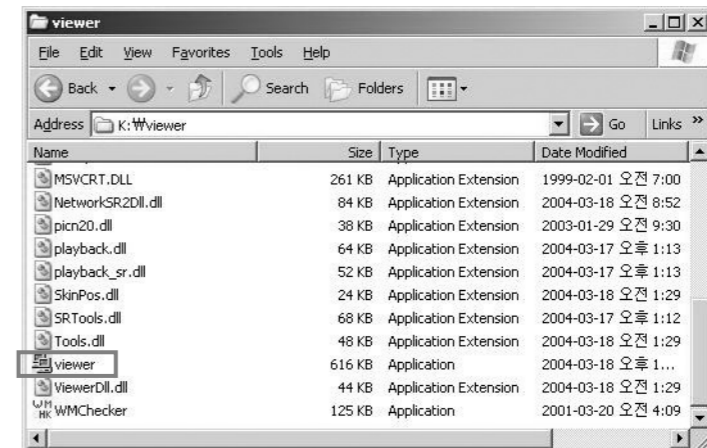

1.2 Viewer Main screen

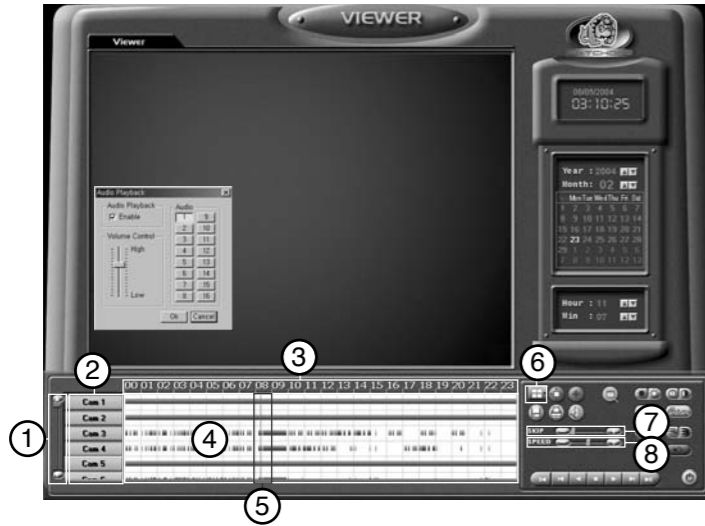

① [Scroll button for camera]

- Scroll up or down to show camera buttons.

② [Camera]

- Select camera number(s) you wish to search.

③ [Time indication bar]

- It indicates time of stored data.
- To enlarge the time scale, click on the time indication bar.

④ [Indication for stored amount]

- This function indicates recording type and stored data in graphical colour form as below ; Pink bar indicates 'Continuous Recording', Blue bar indicates 'Motion Recording', Dark Yellow bar indicates 'Sensor Recording', Green bar indicates 'Pre Alarm', and there will be no graphic bar if nothing was recorded.

⑤ [Search Bar]

- This indicates time line for searching data.

- Move the line to the left or right to start searching.

⑥ [Split Screen setup]

- When you click the button, split mode from search screen will automatically change according to the number of cameras you choose in a form of 4, 9, or 16 split screen.

⑦ [SKIP]

- Move the slides to the right if you wish to increase search speed.
- The number of images to be skipped are set by an internal value of the DW-916 software. The value is not the number of images to be skipped.

⑧ [SPEED]

- Move the slides to the right to increase the speed of replaying saved image.

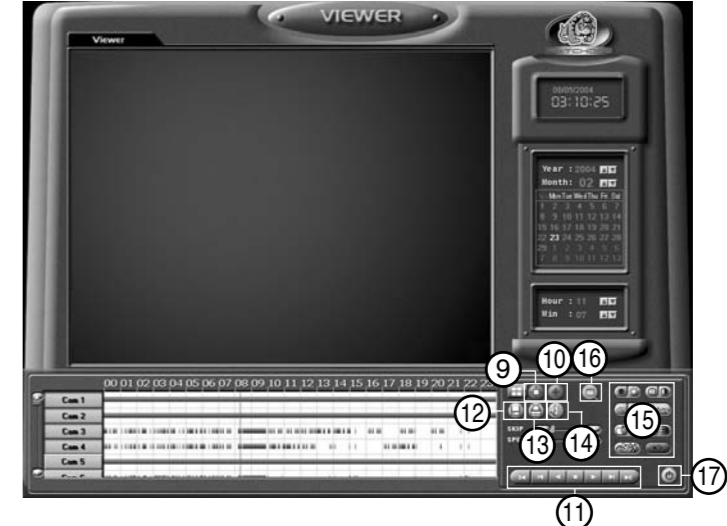

⑨ [Zoom]

- Increases screen size by up to x4.

⑩ [Digital Zoom]

- [Zoom In]
Click right mouse button to increase the selected part of the image by up to x17(when recorded by high resolution)

[Zoom Out]

- Click right mouse button to reduce zoom ratio.

[Move]

- Click right mouse button and drag to "move around inside" the stored image.

⑪ [Playback]

- Be sure to select the camera, time and date to search.
- Adjust SKIP and SPEED ratio as you wish.

- Go to first saved image for selected date
- Reverse play frame by frame
- Reverse playback
- Stop
- Forward playback
- Forward play frame by frame
- Go to last saved image for the selected date

⑫ [Backup]

- While you are searching recorded data, select the image to backup and click . The "Backup" window will appear.

⑬ [Print]

- Print the selected image.
It is possible to print BMP or JPEG images.

⑭ [Audio Play Configuration]

- When you want to playback audio, select the channel with recorded audio. (Audio recording and replay is supported for only one channel)
- When you click the 'Audio Play' icon , the audio play configuration window appears as right.
- Check on "Enable" .
- Adjust the volume properly using "Volume control".



⑮ [Adjustment of playback image]

- Image quality, such as brightness, contrast, colour, sharpness, rotate, mirror, outline and twist function during playback can be adjusted.

⑯ [Search Sheet]

- When you click the icon  for searching the backup data, a window as below will appear.
- Select contains backup data, then select the site you wish to search and click 'Search' to start.

Site Code	Data Type	Date and Time	Time Zone	Path
000001	Live	2005/02/28 05:04	(GMT+09:00)	C:\VCR\NewScreen
000001	Backup	2005/02/28 08:33	(GMT+09:00)	D:\VCR\BACKUP

⑰ [Quit]

- Exit the Viewer program.

2. WebDVR

2.1 WebDVR Connection

① [How to access]

You can access a remote site as a website:

- Open your favorite Web browser.
- Enter the IP address of the Site in the address field of the browser and click [Enter].
- Check the box [DirectX] if you want to get better display performance.
- Enter the site code and the password, and click on the [Login] button.

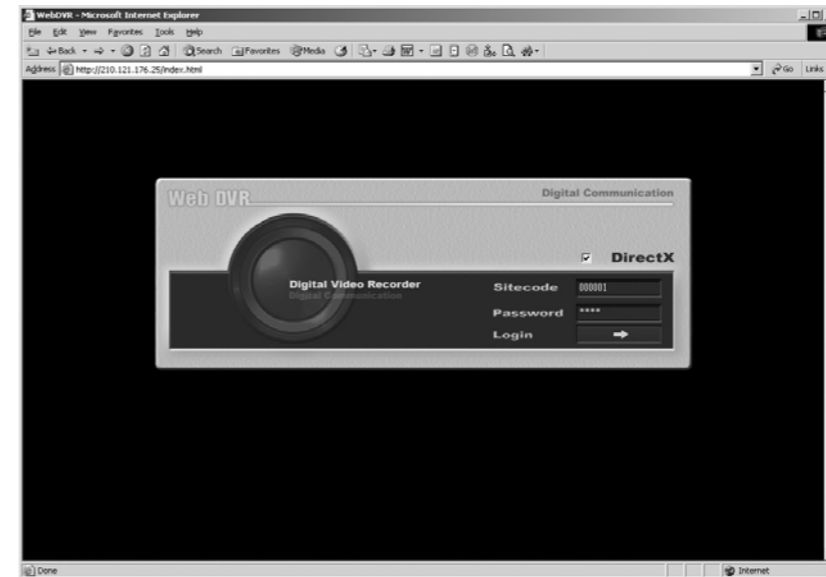

- ② If you select **DirectX** a warning message will appear as blow:

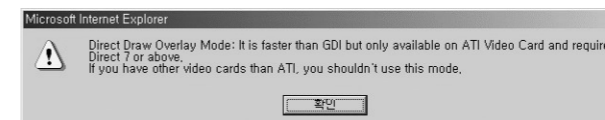

⚠ [Caution]

- ATI video cards is recommended when using DirectX.
- When DirectX is not in use, all video cards are suitable. In the GUI mode, 30~90 fps display is possible.

③ [WebDVR plug-in]

- When accessing the WebDVR program for the first time, a security warning message will appear as shown below. Select “Yes”.

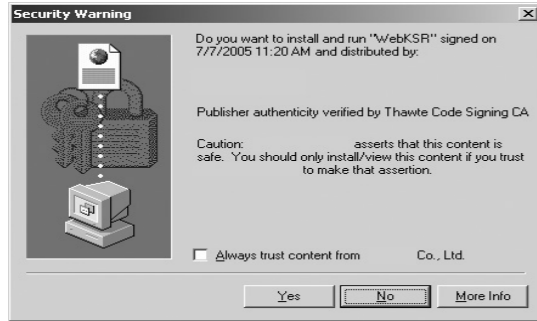

④ [Site Connection]

- As soon as the WebDVR program is connected to the site, the live images from the site will be displayed.



2.2 Using WebDVR Function



- ① If you click on an channel view, its border will turn blue.
(To switch to one-channel-view mode, double-click on the channel view. or click on the channel view then click on the one-screen-split mode button.)
- ② Click on “Stop” button to stop live image transmission. the button label then changes to “Live”. Click on the button again to see live image from the Site.
- ③ [Split Screen]
There are 4 split screen mode: 1-camera, 4-camera, 9-camera and 16-camera modes. you can select a split screen mode by click on the corresponding button. Alternatively, you can select the cameras you wish to see live image from by click on the camera button ⑥ .
- ④ [PAN/TILT and ZOOM/FOCUS control]
Click on the channel view of the camera you wish to control, then use the buttons in ④ to control PTZ and zoom/ focus level.
- ⑤ [QUIT]
Click on exit from WebDVR.

⚠ [Caution]

- You need a RX-receivers (KRE-301 or KRE-302, KRE-303) for each PTZ camera.

2. Specification

▶ System Specification

- HDD : Max. HDD x 4
- O/S : Embedded Linux
- LAN : Ethernet 10/100 MB
- Modem : 56Kbps. External-type modem is supported. (Optional, but not available in Europe)

▶ Video Input

- 16Ch(DW-916)Composite Video (NTSC/PAL)

▶ Video Output

- General Monitor Spot Output (BNC)
- S-Video Output Port
- VGA Output Port
- Video Loop Through Port for Each Video Input

▶ Recording Frame

- DW-916 : NTSC(Max 480 Frame/Sec), PAL (Max 400 Frame/Sec)

▶ Audio Recording

- 16 Channel Audio Support

▶ Compression Method : Mpeg4

▶ Display Mode

- x1, x4, x9, and x16 Screen Division - NTSC : 480 Frame/sec, 16Ch Multi-media Monitoring
PAL : 400 Frame/sec, 16Ch Multi-media Monitoring

▶ Auto Switching

- Automatic channel rotation in order of x1, x4, x9 and x16 Screen Division

▶ Playback Display Mode

- Playing in split screen mode up to 16-splitscreen is possible
- Enlarging an image to full screen is possible

▶ Sensor Input

- 16 channel input

▶ Alarm Output

- 4 alarm output

▶ Rmote Control

▶ Motion Detection - Yes

▶ Camera/Sensor link - Yes

▶ Pan/Tilt/Zoom Control- Yes

▶ Backup

- Auto/Manual backup through USB portable storage device, CD-RW or remote drive through network

▶ Power :

- The rated voltage might vary depending on the specification of the power supply.

Model	Input Voltage
ENP-0812A	AC 100-127V/200-240v, 60/50Hz, 4A/2A
ENP-2320	AC 115-230V, 60-50Hz, 4-2A

▶ Weight : 10.14Kg(HDD x 4)

▶ Dimensions

- Body (mm): 400 (W) x 480 (L) x 105 (H)

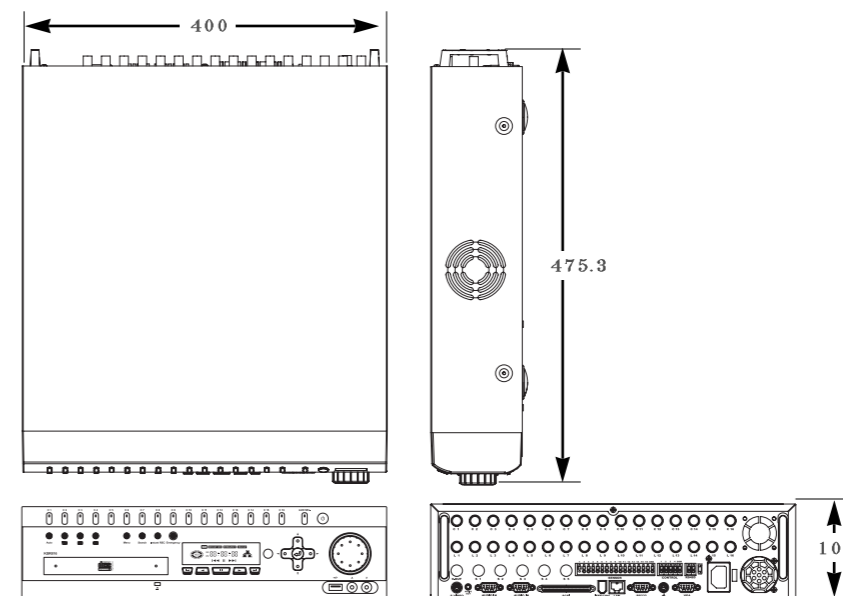

3. FAQ

1

The system power does not turn on.

- ☞ Check if the power cable is connected correctly.
- ☞ Check if the input voltage is correct.
- ☞ If the system power does not turn on when the power cable is connected correctly, please contact the service center.

2

The system power is turned on, but no video data is displayed on the monitor.

- ☞ Check if the monitor power cable is connected properly
- ☞ Check to make sure the monitor is turned on.
- ☞ Check if the video output cable of DVR is properly connected to the monitor.
- ☞ Unplug the power cable and plug in again.
- ☞ For VGA monitor, it takes about a minute to boot. Be sure not to turn off the system until booting is completed.

3

The camera numbers are displayed on the screen, but camera images are not displayed.

- ☞ Check if the camera video output is connected to DVR system correctly.
- ☞ Check if the power cable on the camera is connected correctly.
- ☞ Check if the video cable connecting the camera to DVR system has a problem.
- ☞ This problem can occur because of weak video signal if the video data is transferred by the video data distributor when the video is connected to multiple systems. Connect the camera directly to DVR.
- ☞ Turn off DVR system and turn it on again.

The camera video is shown on the screen, but the system doesn't record video.

4

- ☞ Check to make sure the recording mode in the recording setting mode is not set to "NONE".
- ☞ Turn off the DVR and turn it on again.

It is impossible to search through the recorded video.

5

- ☞ Check if there is a recorded video data at the time that you are trying to search on the table.
- ☞ If there is no recorded video data, check to make sure the recording mode in the recording setting mode is not set to "NONE".

Audio data recorded with video data is not playing.

6

- ☞ Check if the audio recording option is correctly set to the camera you wish to record audio.
- ☞ Check if the audio play option in the Searching mode is selected.
- ☞ Check if the microphone and speaker port on the rear of DVR system are connected correctly.
- ☞ Check if the connected microphone is working properly.
- ☞ Check if the connected speaker is working properly.

7

Color of some camera videos are strange or videos are shown abnormally.

- ☞ Check if the camera connected to the system has a problem. Check to make sure the camera is not damaged by trying another camera into a working video output.
- ☞ Check if the video system setting is the same with your camera system. Depending on your region, the camera system can support either PAL, or NTSC. Depending on the camera system, the video process can differ greatly, therefore it can be difficult to recognize the video data if the video system setting is different from the camera system.

8

There are a lot of (screen) noise on the image.

- ☞ Check if the video signal output from the camera has a problem. Check to make sure the camera is not damaged by trying another camera into a working video output.
- ☞ Check if the video cable connecting the camera and DVR is cut, cross-wired, or shorted.
- ☞ Check if there is a high voltage wire around the video cable connecting the camera to DVR system. It can cause the noise problem to decrease video quality.
- ☞ Check if the video cable connecting the camera to DVR system is the correct video cable. When a normal power-supplying cable is used instead of the video cable, screen noise can be generated.

9

Sometimes the system restarts itself.

- ☞ The system can restart itself due to watchdog function when any problem occurs to DVR.

10

The connected sensor is not operating.

- ☞ Check if the type of sensor in camera setting is the same with the connected sensor.
- ☞ Check if the system is set to use the sensor in recording schedule window in the recording setting menu.
- ☞ Check if the power cable of the sensor is properly connected.
- ☞ Check if the signal cable of the sensor is properly connected.

11

The connected control device is not operating.

- ☞ Check if the system is set to use the control device in the camera setting menu.
- ☞ Check if the power cable of the controller is properly connected.
- ☞ Check if the signal cable of the controller is properly connected.

Warranty Guide

The quality of this product is guaranteed by strict quality control processes and testing. If the product becomes non operational the warranty may be in operation. The warranty period is valid for 1 year from the date of purchase.

Warranty Guide

- Check the Product Warranty Sheet to make sure it is still in effect.
- Check the problem again and contact the dealer you purchased the unit from.
- About product repair, exchange, or refund, we follow the "compensation regulation for customer's loss" announced by "the Economic Planning Board". (Korea only)

Warranty

- If the product becomes non operational the warranty may be in operation. The warranty period is valid for 1 year from the date of purchase.
- Service fee and replacement parts will be charged in below cases:
 1. Damaged the user's carelessness.
 2. Damaged due to a natural disaster.
 3. Damaged due to the user not following the instructions and cautions written in the user's guide.
 4. Damaged due to incorrect power voltage, and/or frequency being used.
 5. If the Product Warranty sheet is expired.
 6. Damaged due to an engineer not employed by Kaltech modifying the system.
- If your system is damaged after the expiration of the warranty period, free repair service will not be available. If you wish the system to be repaired, a service fee and replacement parts will be charged on a time & materials basis.

Product Warranty

Product/Model Name		
Serial Number		
Purchasing Dealer		
Purchasing Date		
Warranty Period		1 year from the purchasing date.
Customer	Name	
	Address	

- The Product Warranty Sheet will not be issued again.
- The Product Warranty Sheet must be filled on the same day as the product's purchase.
- This document must be shown in order to receive the free repair service.

- Tech Support : 866-446-3595
- Fax : 813-888-9262
- E-Mail : Helpdesk@kaltech.net

